



User Manual

SOM-6867

ADVANTECH

Enabling an Intelligent Planet

Copyright

The documentation and the software included with this product are copyrighted 2015 by Advantech Co., Ltd. All rights are reserved. Advantech Co., Ltd. reserves the right to make improvements in the products described in this manual at any time without notice. No part of this manual may be reproduced, copied, translated or transmitted in any form or by any means without the prior written permission of Advantech Co., Ltd. Information provided in this manual is intended to be accurate and reliable. However, Advantech Co., Ltd. assumes no responsibility for its use, nor for any infringements of the rights of third parties, which may result from its use.

Acknowledgements

Intel® and Pentium® are trademarks of Intel Corporation.

Microsoft Windows and MS-DOS are registered trademarks of Microsoft Corp.

All other product names or trademarks are properties of their respective owners.

Product Warranty (2 years)

Advantech warrants to you, the original purchaser, that each of its products will be free from defects in materials and workmanship for two years from the date of purchase.

This warranty does not apply to any products which have been repaired or altered by persons other than repair personnel authorized by Advantech, or which have been subject to misuse, abuse, accident or improper installation. Advantech assumes no liability under the terms of this warranty as a consequence of such events.

Because of Advantech's high quality-control standards and rigorous testing, most of our customers never need to use our repair service. If an Advantech product is defective, it will be repaired or replaced at no charge during the warranty period. For out-of-warranty repairs, you will be billed according to the cost of replacement materials, service time and freight. Please consult your dealer for more details.

If you think you have a defective product, follow these steps:

1. Collect all the information about the problem encountered. (For example, CPU speed, Advantech products used, other hardware and software used, etc.) Note anything abnormal and list any onscreen messages you get when the problem occurs.
2. Call your dealer and describe the problem. Please have your manual, product, and any helpful information readily available.
3. If your product is diagnosed as defective, obtain an RMA (return merchandise authorization) number from your dealer. This allows us to process your return more quickly.
4. Carefully pack the defective product, a fully-completed Repair and Replacement Order Card and a photocopy proof of purchase date (such as your sales receipt) in a shippable container. A product returned without proof of the purchase date is not eligible for warranty service.
5. Write the RMA number visibly on the outside of the package and ship it prepaid to your dealer.

Declaration of Conformity

CE

This product has passed the CE test for environmental specifications. Test conditions for passing included the equipment being operated within an industrial enclosure. In order to protect the product from being damaged by ESD (Electrostatic Discharge) and EMI leakage, we strongly recommend the use of CE-compliant industrial enclosure products.

FCC Class B

Note: This equipment has been tested and found to comply with the limits for a Class B digital device, pursuant to part 15 of the FCC Rules. These limits are designed to provide reasonable protection against harmful interference in a residential installation. This equipment generates, uses and can radiate radio frequency energy and, if not installed and used in accordance with the instructions, may cause harmful interference to radio communications. However, there is no guarantee that interference will not occur in a particular installation. If this equipment does cause harmful interference to radio or television reception, which can be determined by turning the equipment off and on, the user is encouraged to try to correct the interference by one or more of the following measures:

- Reorient or relocate the receiving antenna.
- Increase the separation between the equipment and receiver.
- Connect the equipment into an outlet on a circuit different from that to which the receiver is connected.
- Consult the dealer or an experienced radio/TV technician for help.

FM

This equipment has passed the FM certification. According to the National Fire Protection Association, work sites are classified into different classes, divisions and groups, based on hazard considerations. This equipment is compliant with the specifications of Class I, Division 2, Groups A, B, C and D indoor hazards.

Technical Support and Assistance

1. Visit the Advantech website at <http://support.advantech.com> where you can find the latest information about the product.
2. Contact your distributor, sales representative, or Advantech's customer service center for technical support if you need additional assistance. Please have the following information ready before you call:
 - Product name and serial number
 - Description of your peripheral attachments
 - Description of your software (operating system, version, application software, etc.)
 - A complete description of the problem
 - The exact wording of any error messages

Warnings, Cautions and Notes

Warning! Warnings indicate conditions, which if not observed, can cause personal injury!



Caution! Cautions are included to help you avoid damaging hardware or losing data. e.g.



There is a danger of a new battery exploding if it is incorrectly installed. Do not attempt to recharge, force open, or heat the battery. Replace the battery only with the same or equivalent type recommended by the manufacturer. Discard used batteries according to the manufacturer's instructions.

Note! Notes provide optional additional information.



Document Feedback

To assist us in making improvements to this manual, we would welcome comments and constructive criticism. Please send all such comments in writing to: support@advantech.com

Packing List

Before setting up the system, check that the items listed below are included and in good condition. If any item does not accord with the table, please contact your dealer immediately.

- SOM-6867 CPU module
- 1 x Heat spreader (1960065753N001)

Safety Instructions

1. Read these safety instructions carefully.
2. Keep this User Manual for later reference.
3. Disconnect this equipment from any AC outlet before cleaning. Use a damp cloth. Do not use liquid or spray detergents for cleaning.
4. For plug-in equipment, the power outlet socket must be located near the equipment and must be easily accessible.
5. Keep this equipment away from humidity.
6. Put this equipment on a reliable surface during installation. Dropping it or letting it fall may cause damage.
7. The openings on the enclosure are for air convection. Protect the equipment from overheating. **DO NOT COVER THE OPENINGS.**
8. Make sure the voltage of the power source is correct before connecting the equipment to the power outlet.
9. Position the power cord so that people cannot step on it. Do not place anything over the power cord.
10. All cautions and warnings on the equipment should be noted.
11. If the equipment is not used for a long time, disconnect it from the power source to avoid damage by transient overvoltage.
12. Never pour any liquid into an opening. This may cause fire or electrical shock.
13. Never open the equipment. For safety reasons, the equipment should be opened only by qualified service personnel.
14. If one of the following situations arises, get the equipment checked by service personnel:
 - The power cord or plug is damaged.
 - Liquid has penetrated into the equipment.
 - The equipment has been exposed to moisture.
 - The equipment does not work well, or you cannot get it to work according to the user's manual.
 - The equipment has been dropped and damaged.
 - The equipment has obvious signs of breakage.
15. **DO NOT LEAVE THIS EQUIPMENT IN AN ENVIRONMENT WHERE THE STORAGE TEMPERATURE MAY GO BELOW -20° C (-4° F) OR ABOVE 60° C (140° F). THIS COULD DAMAGE THE EQUIPMENT. THE EQUIPMENT SHOULD BE IN A CONTROLLED ENVIRONMENT.**
16. **CAUTION: DANGER OF EXPLOSION IF BATTERY IS INCORRECTLY REPLACED. REPLACE ONLY WITH THE SAME OR EQUIVALENT TYPE RECOMMENDED BY THE MANUFACTURER, DISCARD USED BATTERIES ACCORDING TO THE MANUFACTURER'S INSTRUCTIONS.**

The sound pressure level at the operator's position according to IEC 704-1:1982 is no more than 70 dB (A).

DISCLAIMER: This set of instructions is given according to IEC 704-1. Advantech disclaims all responsibility for the accuracy of any statements contained herein.

Safety Precaution - Static Electricity

Follow these simple precautions to protect yourself from harm and the products from damage.

- To avoid electrical shock, always disconnect the power from your PC chassis before you work on it. Don't touch any components on the CPU card or other cards while the PC is on.
- Disconnect power before making any configuration changes. The sudden rush of power as you connect a jumper or install a card may damage sensitive electronic components.

Contents

Chapter 1	General Information	1
1.1	Introduction	2
1.2	Specifications	2
1.2.1	Board Information	2
1.2.2	System Information	2
1.2.3	Display	3
1.2.4	Expansion Interface	3
1.2.5	I/O	3
1.2.6	iManager 2.0	3
1.2.7	Mechanical and Environmental Specification	4
1.3	Functional Block Diagram	4
	Figure 1.1 Functional Block Diagram.....	4
Chapter 2	Mechanical Information	5
2.1	Board Information.....	6
	Figure 2.1 Board Chips Identify - Front.....	6
	Figure 2.2 Board Chips Identify - Back	6
2.1.1	Connector List.....	7
	Table 2.1: FAN1 Fan	7
2.2	Mechanical Drawing.....	7
	Figure 2.3 Board Mechanical Drawing - Front	7
	Figure 2.4 Board Mechanical Drawing - Back	8
	Figure 2.5 Board Mechanical Drawing - Back	8
2.3	Assembly Drawing	9
	Figure 2.6 Assembly Drawing.....	9
Chapter 3	BIOS	11
3.1	Entering Setup	12
	Figure 3.1 Setup Program Initial Screen.....	12
3.2	Main Setup	13
	Figure 3.2 Main Setup Screen	13
3.3	Advanced BIOS Features Setup	14
	Figure 3.3 Advanced BIOS Features Setup Screen	14
3.3.1	Trusted Computing	15
	Figure 3.4 Trusted Computing Settings	15
3.3.2	ACPI Settings.....	16
	Figure 3.5 ACPI Settings	16
3.3.3	Intel® Smart Connect Technology	17
	Figure 3.6 Intel(R) Smart Connect Technology	17
3.3.4	W83627DHG Super IO Configuration	18
	Figure 3.7 W83627DHG Super IO Configuration	18
	Figure 3.8 Serial Port 0 Configuration	19
	Figure 3.9 Serial Port 1 Configuration	20
	Figure 3.10 Parallel Port Configuration.....	21
3.3.5	iManager Configuration.....	22
	Figure 3.11 iManager Configuration	22
	Figure 3.12 Serial Port 2 Configuration	23
	Figure 3.13 Serial Port 3 Configuration	24
	Figure 3.14 Hardware Monitor	25
3.3.6	Serial Port Console Redirection	26
	Figure 3.15 Serial Port Console Redirection	26

3.3.7	CPU Configuration.....	27
	Figure 3.16CPU Redirection.....	27
	Figure 3.17Socket 0 CPU Information.....	28
	Figure 3.18CPU Thermal Configuration.....	29
3.3.8	PPM Configuration.....	30
	Figure 3.19PPM Configuration.....	30
3.3.9	IDE Configuration.....	31
	Figure 3.20IDE Configuration.....	31
3.3.10	Network Stack Configuration.....	32
	Figure 3.21Network Stack Configuration.....	32
3.3.11	CSM Configuration.....	33
	Figure 3.22CSM Configuration.....	33
3.3.12	USB Configuration.....	34
	Figure 3.23USB Configuration.....	34
3.3.13	Security Configuration.....	35
	Figure 3.24Security Configuration.....	35
3.4	Chipset.....	36
	Figure 3.25Chipset Setup.....	36
3.4.1	North Bridge.....	37
	Figure 3.26North Bridge.....	37
	Figure 3.27Intel IGD Configuration.....	38
	Figure 3.28Graphics Power Management Control.....	39
	Figure 3.29LCD Control.....	40
3.4.2	South Bridge.....	41
	Figure 3.30South Bridge.....	41
	Figure 3.31Azalia HD Audio.....	42
	Figure 3.32USB Configuration.....	43
	Figure 3.33PCI Express Configuration.....	44
3.5	Security.....	45
	Figure 3.34Security.....	45
3.6	Boot.....	46
	Figure 3.35Security.....	46
3.7	Save & Exit.....	47
	Figure 3.36Save & Exit.....	47
3.7.1	Save Changes and Exit.....	47
3.7.2	Discard Changes and Exit.....	47
3.7.3	Save Changes and Reset.....	47
3.7.4	Discard Changes and Reset.....	47
3.7.5	Save Changes.....	47
3.7.6	Discard Changes.....	48
3.7.7	Restore Defaults.....	48
3.7.8	Save as User Defaults.....	48
3.7.9	Restore User Defaults.....	48
3.7.10	Launch EFI Shell from filesystem device.....	48
3.8	EnableUSB 3.0.....	48
3.9	BIOS/FW Supported Matrix.....	50

Chapter 4 S/W Introduction & Installation..... 51

4.1	S/W Introduction.....	52
4.2	Driver Installation.....	52
	4.2.1 Windows Driver Setup.....	52
	4.2.2 Other OS.....	52
4.3	Advantech iManager.....	52

Appendix A Pin Assignment..... 55

A.1	SOM-6867 Type 6 Pin Assignment.....	56
-----	-------------------------------------	----

Appendix B	Watchdog Timer	61
B.1	Programming the Watchdog Timer	62
Appendix C	Programming GPIO	63
C.1	GPIO Register	64
Appendix D	System Assignments	65
D.1	System I/O Ports	66
	Table D.1: System I/O ports	66
D.2	DMA Channel Assignments	67
	Table D.2: DMA channel assignments	67
D.3	Interrupt Assignments	67
	Table D.3: Interrupt assignments	67
D.4	1st MB Memory Map	68
	Table D.4: 1st MB Memory Map	68

Chapter 1

General Information

This chapter gives background information on the SOM-6867 CPU Computer on Module

Sections include:

- Introduction
- Specification
- Functional Block Diagram

1.1 Introduction

SOM-6867 is a COM-Express Compact module with pin-out Type 6 that fully complies with the PICMG (PCI Industrial Computer Manufacturers Group) COM.0 R2.1 specification. The CPU module incorporates an Intel Atom E series and Celeron N/J series processor and other peripheral chips to fulfill COM specific functions. The Intel latest processor uses 22nm. This generation brings 3 times more performance improvements than previous generations, and integrates powerful Intel HD Graphics as well as DX11.1, OpenGL3.0, OCL1.2 MPEG2, AVC/H.264, and VC-1 HW decode/acceleration. SOM-6867 provides a variety of interfaces such as PCI Express, SATA Gen 2 USB3.0, USB client, and advanced optional functions for on-board storage. Moreover, PCIe x4 can be used as x4 or x1 - making SOM-6867 more flexible.

Advantech iManager 2.0 satisfies a lot of embedded application requirements with multi-level watchdog timer, voltage and temperature monitoring, thermal protection through processor throttling, as well as LCD backlight on/off and brightness control, embedded storage for customized information, and more. With Advantech SUSI Access, you can remotely monitor and control devices for easy maintenance. All Advantech COM Express modules integrate iManager and SUSI Access to benefit your applications.

SOM-6867 is suitable for entry level portable computing applications needing thermally sensitive, rugged, graphics/media/display and I/O demanding designs.

1.2 Specifications

1.2.1 Board Information

- **Pin Definition:** PICMG COM.0 R2.1 Type 6 pin-out definition
- **Form Factor:** PICMG COM.0 R2.1 Compact Module 95 x 95 mm

1.2.2 System Information

- **CPU:** Intel® Atom/Celeron Processor

CPU	Standard Freq.	Max. TurboFreq.	Core	Cache (MB)	TDP(W)
J1900	2.4GHz	2.42G	4	2	10
E3845	1.9GHz	2.42G	4	2	10
E3827	1.75GHz	-	2	1	8
			4	2	10
			2		8

- **Memory:** 2 SODIMM Socket for DDR3L-1333/1066, up to 8GB
- **BIOS:** AMI UEFI SPI BIOS
- **Power management:** Supports power saving modes including Normal / Standby / Suspend modes. ACPI 2.0 compliant

1.2.3 Display

- **Graphic Core:** Intel® HD Graphic supports DX11.1, OGL3.0, PCL1.2 and MPEG2, AVC/H.264, VC-1 HW decode/encode/transcode acceleration
- **VGA:** Resolution up to 2560 x 1600
- **LVDS:** Supports single/dual channel 18/24-bit, resolution up to 1920 x 1200
- **HDMI/DVI/DP:** Supports 2 ports HDMI, DVI, or DP multiplexed. Resolution: HDMI up to 1920 x1200

DVI up to 2560 x1600
eDP up to 2560 x1600

- **Dual Display:**
 - VGA + LVDS,
 - VGA + HDMI/DVI/DP
 - LVDS + HDMI/DVI/DP
 - HDMI/DVI/DP + HDMI/DVI/DP

1.2.4 Expansion Interface

- **PCI Express x1:** Support default 4 ports PCIe x1 compliant to PCIe Gen2 (3.0 GT/s) specification, several configurable combinations may need BIOS modifies. Please contact Advantech sales or FAE for more details.
- **Audio Interface:** Intel HD Audio interface
- **LPC Bus**
- **SMBus**
- **I2C Bus**
- **SPI**

1.2.5 I/O

- **Ethernet:** Intel I210 Gigabit LAN supports 10/100/1000 Mbps Speed
- **SATA:** Supports 2 ports SATA Gen2
- **USB Interface:** Supports 1 port USB3.0, 8 ports USB 2.0
- **Serial Port:** Supports 2 ports 2-wire serial port
- **Express Card:** 2 ports
- **Panel Control:** Supports panel backlight on/off control, brightness control
- **Thermal Protection:** Supports thermal shutdown or CPU throttling
- **Watchdog Timer:** 65536 level timer interval, from 0~65535 sec, multi-level, multi-option watchdog timer
- **Smart Fan:** 1 port on Module, 1 port down to carrier board
- **GPIO:** 8-bit GPIO
- **Hardware Monitor:** Vin, 5VSB, CMOS

1.2.6 iManager 2.0

Refer to section 4.3

1.2.7 Mechanical and Environmental Specification

- **Dimensions:** 95 x 95 mm (3.74" x 3.74")
- **Power Type and Supply Voltage:**
 - ATX: +8.5~20V and +4.75~5.25VSB (standby power)
 - AT: +8.5~20V
 - CMOS Battery: +3.3V
- **Temperature Specification:**
 - Operating: 0 ~ 60°C (32 ~ 140°F)
 - Storage: -40 ~ 85°C (-40 ~ 185°F)
- **Humidity Specification:**
 - Operating: 40°C@95% relative humidity, non-condensing
 - Storage: 60°C@95%relative humidity, non-condensing

1.3 Functional Block Diagram

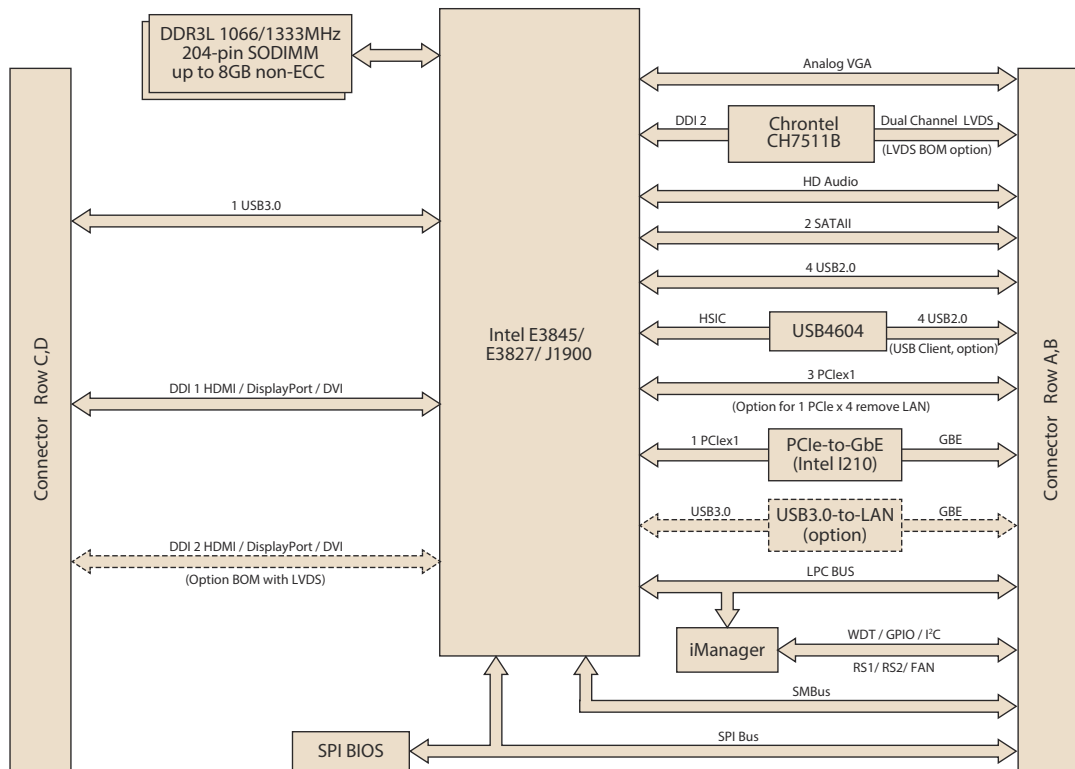

Figure 1.1 Functional Block Diagram

Chapter 2

Mechanical Information

This chapter gives mechanical information on the SOM-6867 CPU Computer on Module

Sections include:

- Board Information
- Mechanical Drawing
- Assembly Drawing

2.1 Board Information

The figures below indicate the main chips on SOM-6867 Computer-on-Module. Please aware on these positions while designing your carrier board to avoid mechanical and thermal issues for best performance.

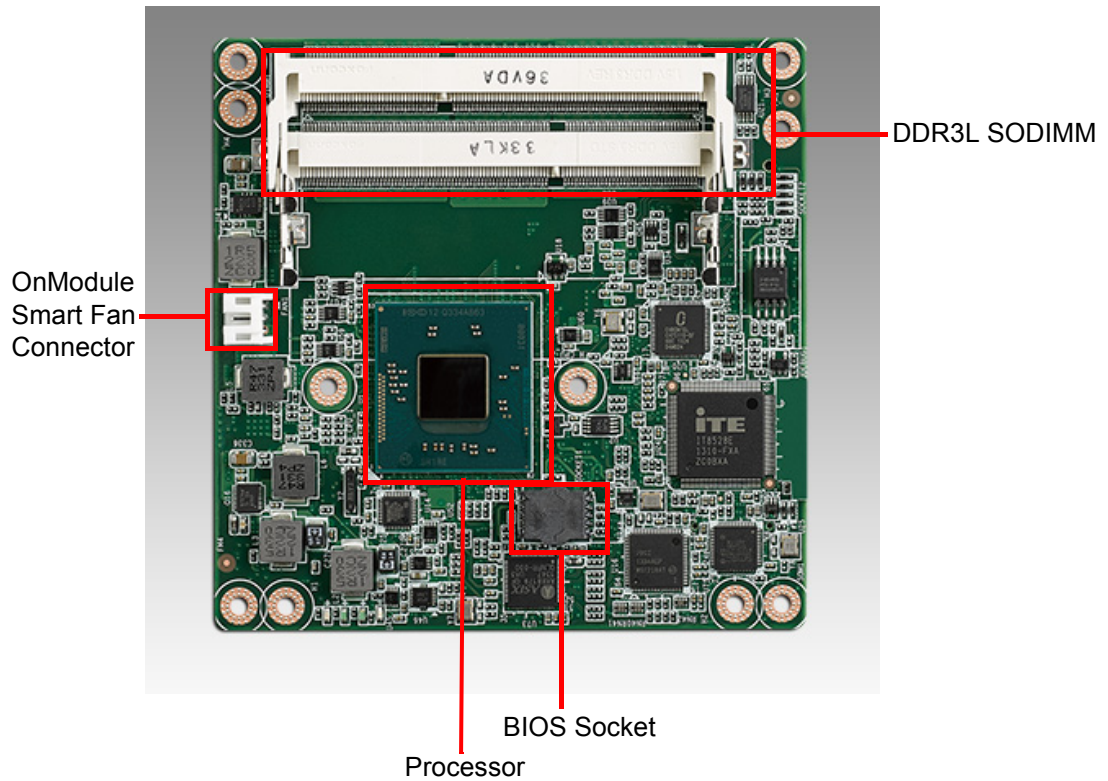

Figure 2.1 Board Chips Identify - Front

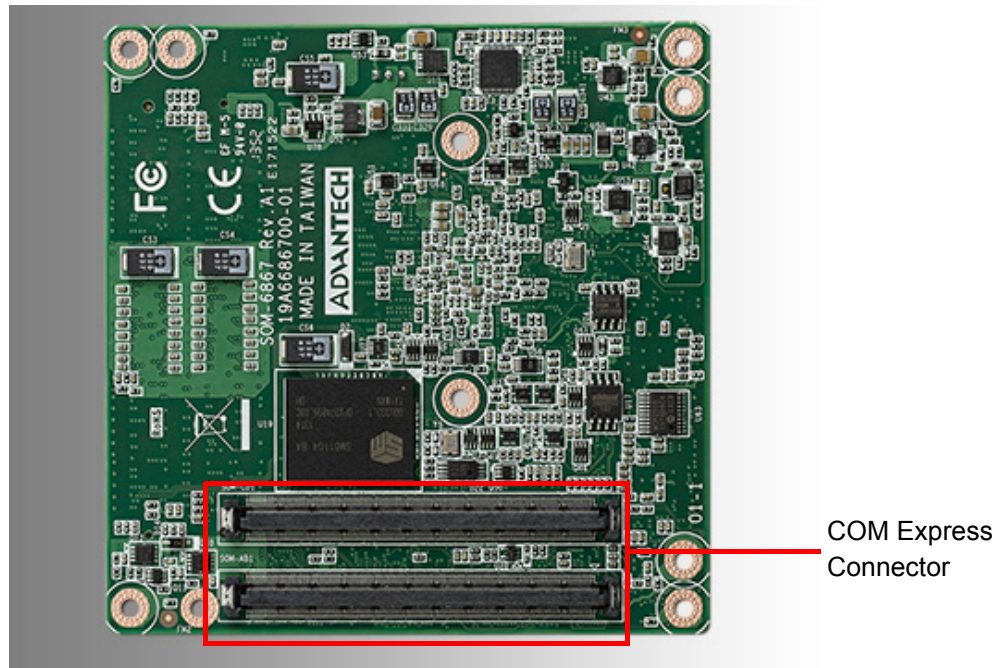

Figure 2.2 Board Chips Identify - Back

2.1.1 Connector List

Table 2.1: FAN1 Fan

FAN1	Fan
Description	Wafer 2.0, 3P 90D(M)DIP 2001-WR-03-LF W/Lock
Pin	Pin Name
1	Fan Tacho-Input
2	Fan Out
3	GND



2.2 Mechanical Drawing

For more detail about 2D/3D models, please find on Advantech COM support service website <http://com.advantech.com>.

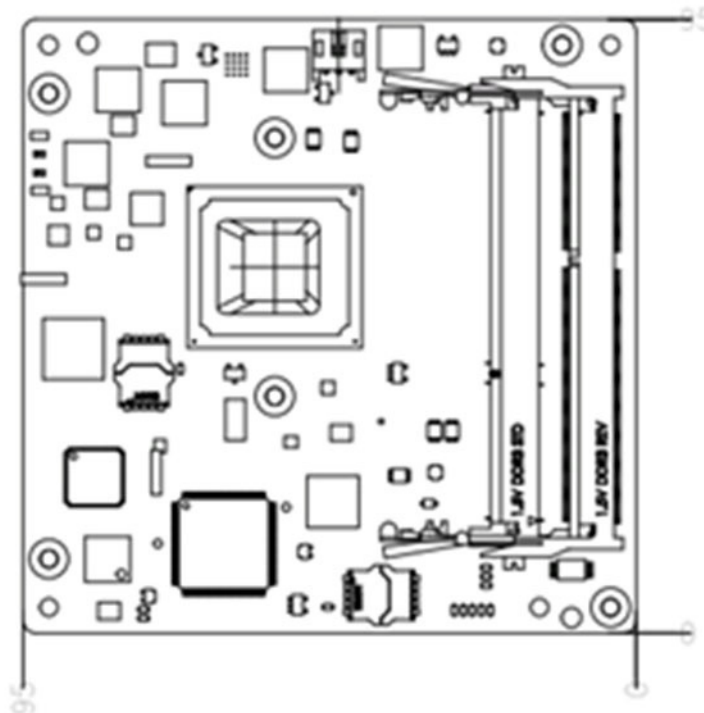

Figure 2.3 Board Mechanical Drawing - Front

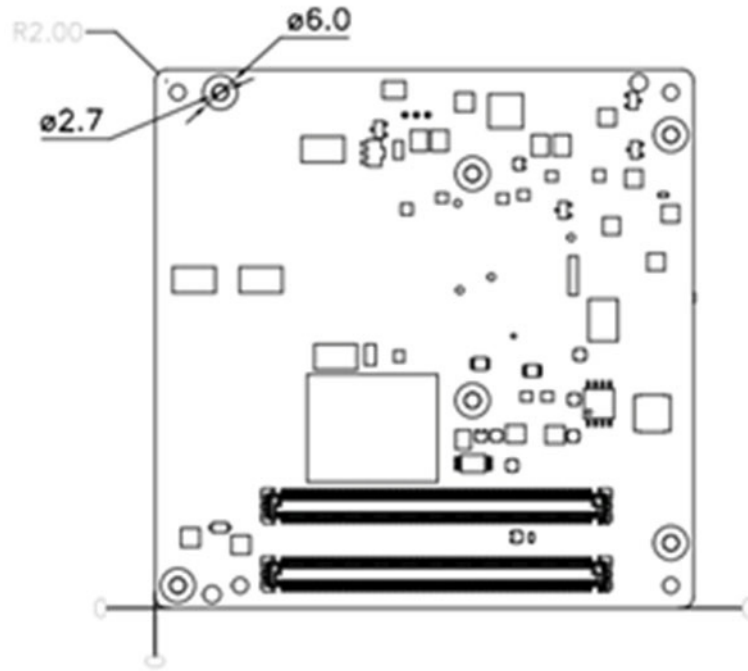

Figure 2.4 Board Mechanical Drawing - Back



Figure 2.5 Board Mechanical Drawing - Back

2.3 Assembly Drawing

These figures demonstrate the assembly order from thermal module, COM module to carrier board.

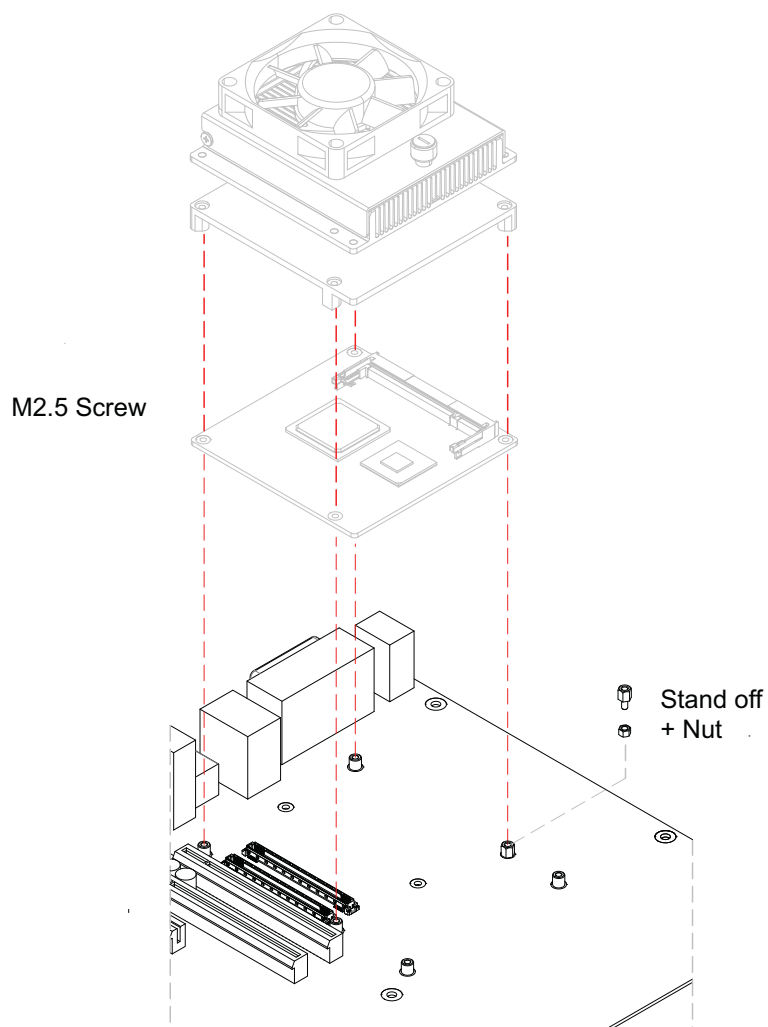

Figure 2.6 Assembly Drawing

There are 4 reserved screw holes for SOM-6867 to be pre-assembled with heat spreader.

Chapter 3

BIOS

This chapter gives BIOS setup information for the SOM-6867 Computer on Module board

Sections include:

- Introduction
- Entering Setup
- Hot / Operation Key
- Exit BIOS Setup Utility
- EnableUSB 3.0
- BIOS/FW Supported Matrix

3.1 Entering Setup

SOM-6867 BIOS has been stored into a flash ROM which is soldered on board. With the BIOS Setup program, users can modify BIOS settings and control various system features. This chapter describes the basic navigation of the SOM-6867 BIOS setup screens.

Advantech will have revision for product optimization, and users can re-flash the latest BIOS through the AFU utility. Please contact to Advantech sales or FAE for more details.

Turn on the computer and then press <ESC> or to enter Setup menu.

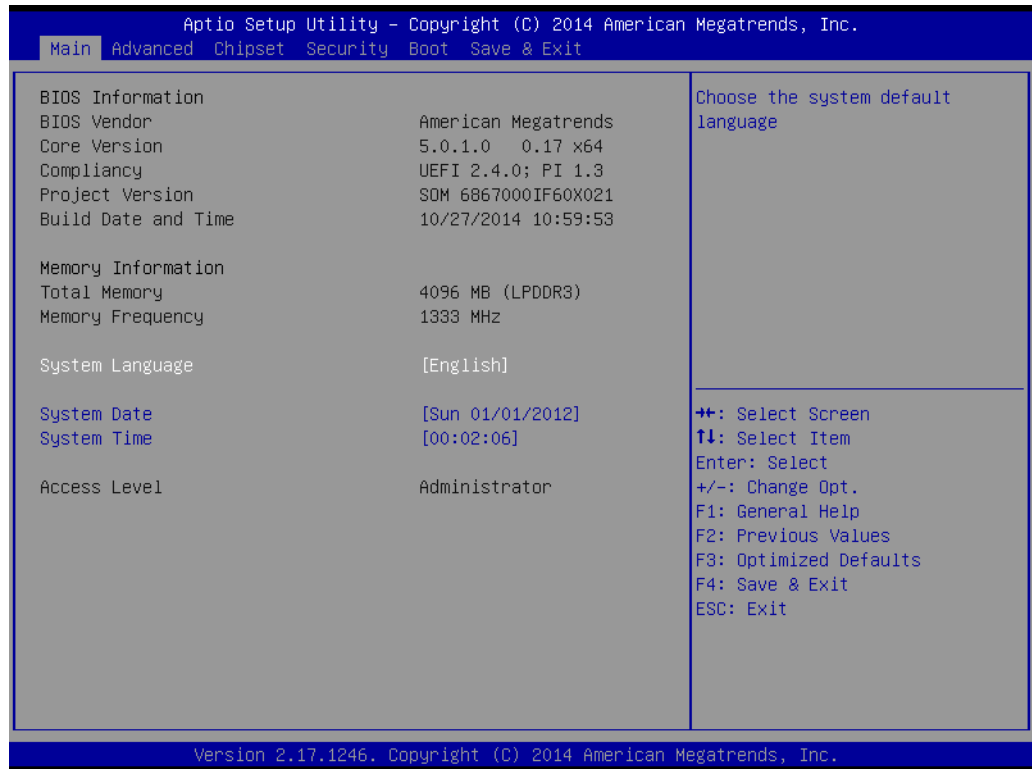

Figure 3.1 Setup Program Initial Screen

SOM-6867 BIOS has a built-in Setup program that allows users to modify the basic system configuration. This information is stored in flash ROM so it retains the Setup information when the power is turned off.

3.3 Advanced BIOS Features Setup

Select the Advanced tab from the SOM-6867 setup screen to enter the Advanced BIOS Setup screen. Users can select any item in the left frame of the screen, such as CPU Configuration, to go to the sub menu for that item. Users can display an Advanced BIOS Setup option by highlighting it using the <Arrow> keys. All Advanced BIOS Setup options are described in this section. The Advanced BIOS Setup screens are shown below. The sub menus are described on the following pages.

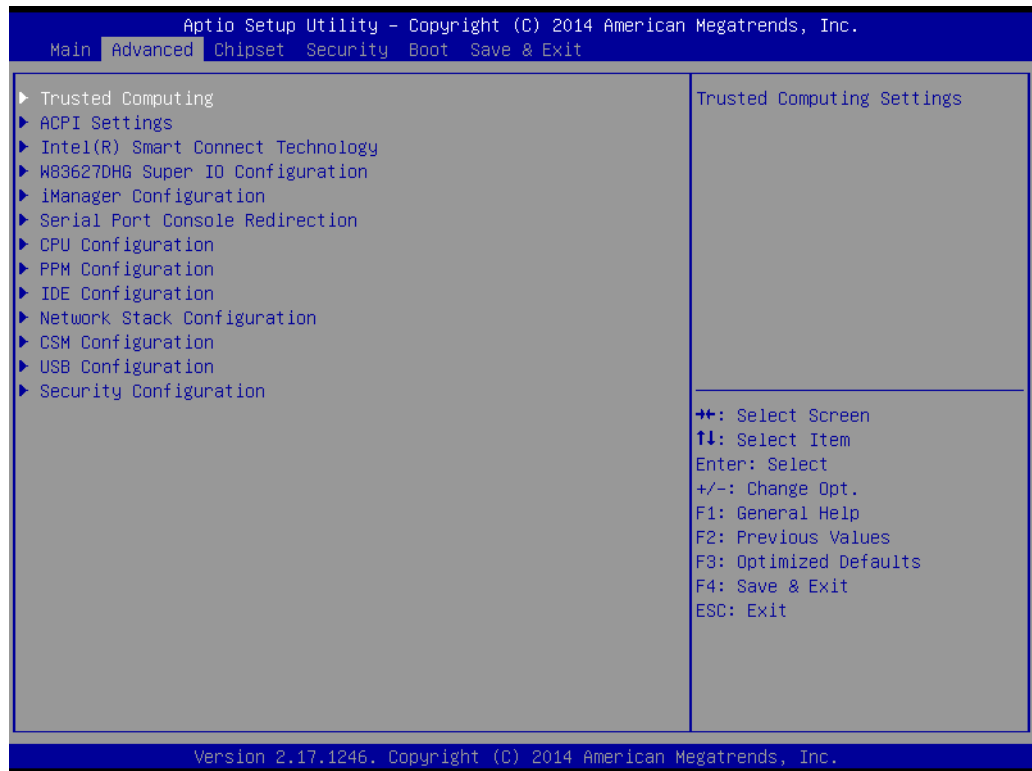

Figure 3.3 Advanced BIOS Features Setup Screen

3.3.1 Trusted Computing

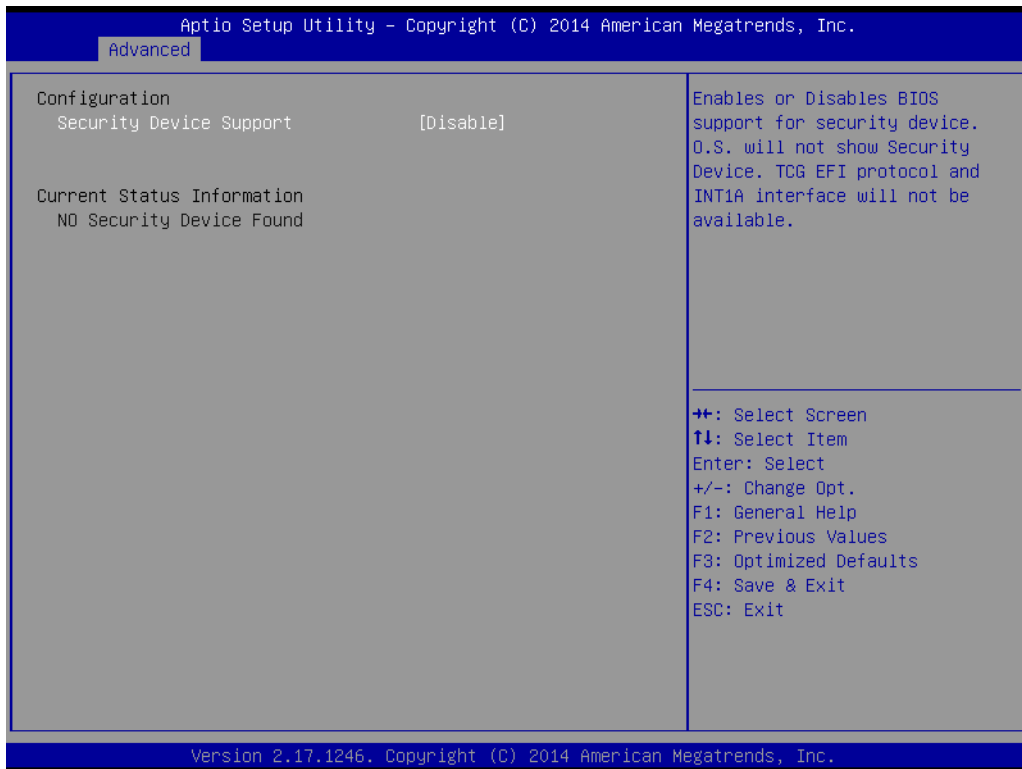

Figure 3.4 Trusted Computing Settings

- **Security Device Support**
This item allows users to enable or disable BIOS support for security device.

3.3.2 ACPI Settings

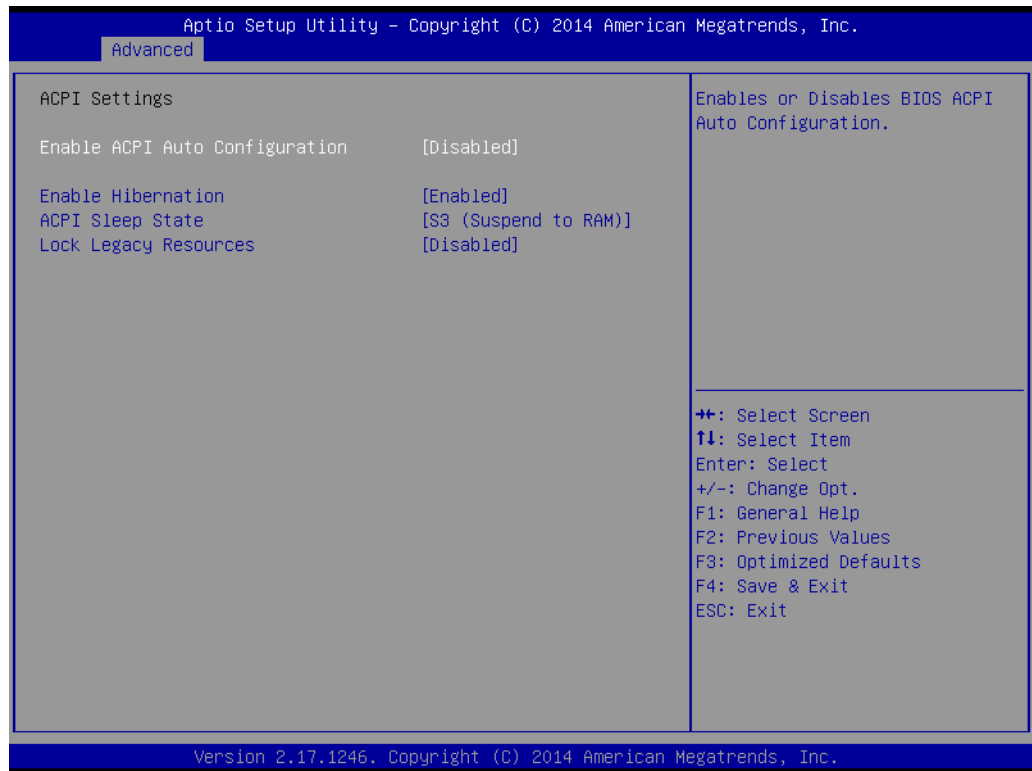

Figure 3.5 ACPI Settings

- **Enable ACPI Auto Configuration**
This item allows users to enable or disable BIOS ACPI auto configuration.
- **Enable Hibernation**
This item allows users to enable or disable hibernation.
- **ACPI Sleep State**
This item allows users to set the ACPI sleep state.
- **Lock Legacy Resources**
This item allows users to lock legacy devices' resources.

3.3.3 Intel® Smart Connect Technology



Figure 3.6 Intel(R) Smart Connect Technology

- **ISCT Support**
Disable/Enable ISCT Support.

3.3.4 W83627DHG Super IO Configuration

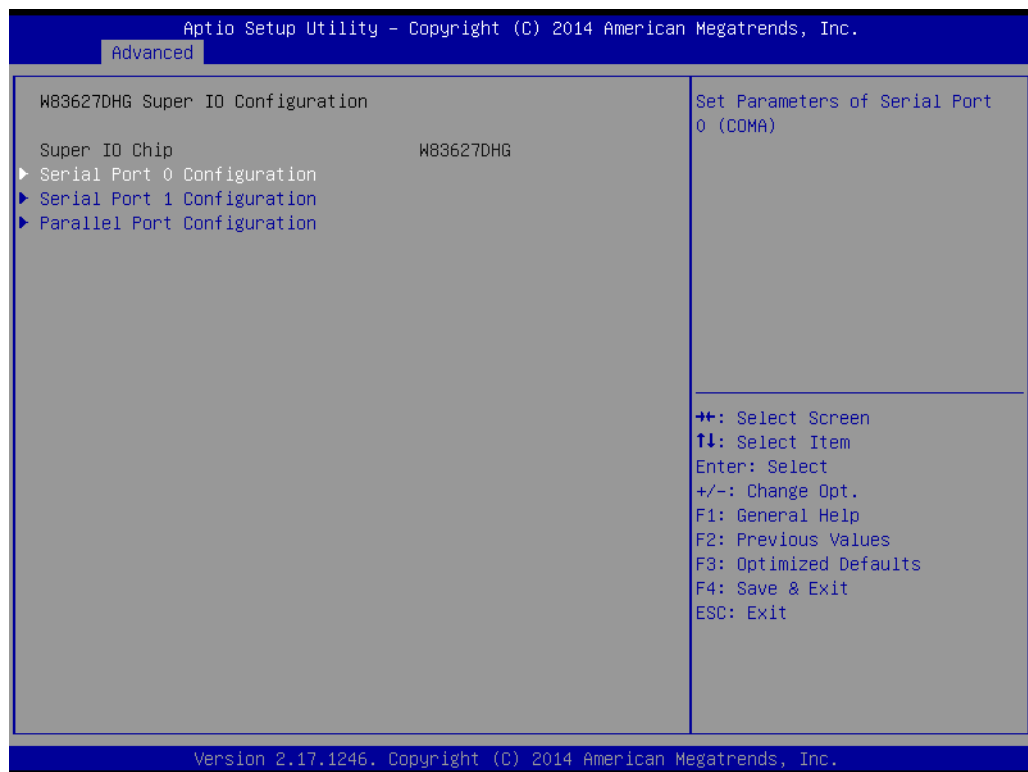

Figure 3.7 W83627DHG Super IO Configuration

- **Serial Port 0 Configuration**
This item allows users to set parameters of Serial Port 0.
- **Serial Port 1 Configuration**
This item allows users to set parameters of Serial Port 1.
- **Parallel Port Configuration**
This item allows users to set parameters of Parallel Port (LPT/LPTE).

3.3.4.1 Serial Port 0 Configuration

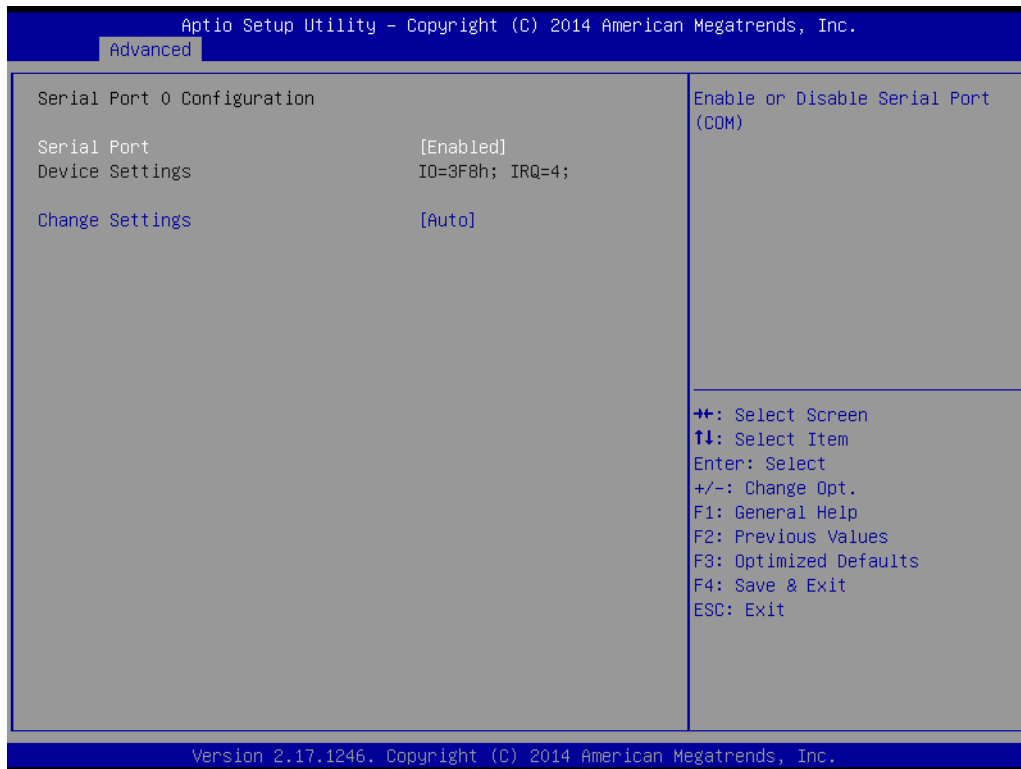

Figure 3.8 Serial Port 0 Configuration

- **Serial Port**
This item allows users to enable or disable Serial Port (COM).
- **Change Setting**
This item allows users to select and optimal setting for Super IO device.

3.3.4.2 Serial Port 1 Configuration

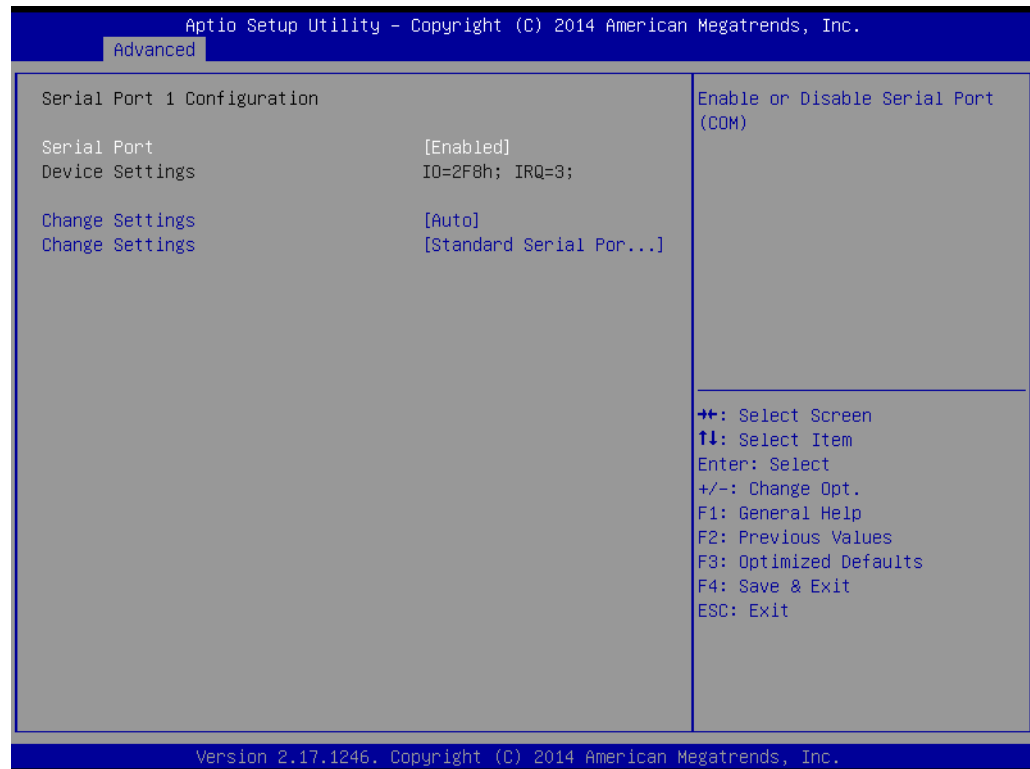

Figure 3.9 Serial Port 1 Configuration

- **Serial Port**
This item allows users to enable or disable Serial Port (COM).
- **Change Setting**
This item allows users to select and optimal setting for Super IO device.

3.3.4.3 Parallel Port Configuration



Figure 3.10 Parallel Port Configuration

- **Parallel Port**
This item allows users to enable or disable Parallel Port (LPT/LPTE).
- **Change Setting**
This item allows users to select and optimal setting for Super IO device.
- **Device Mode**
This item allows users to change the Printer Port mode.

3.3.5 iManager Configuration

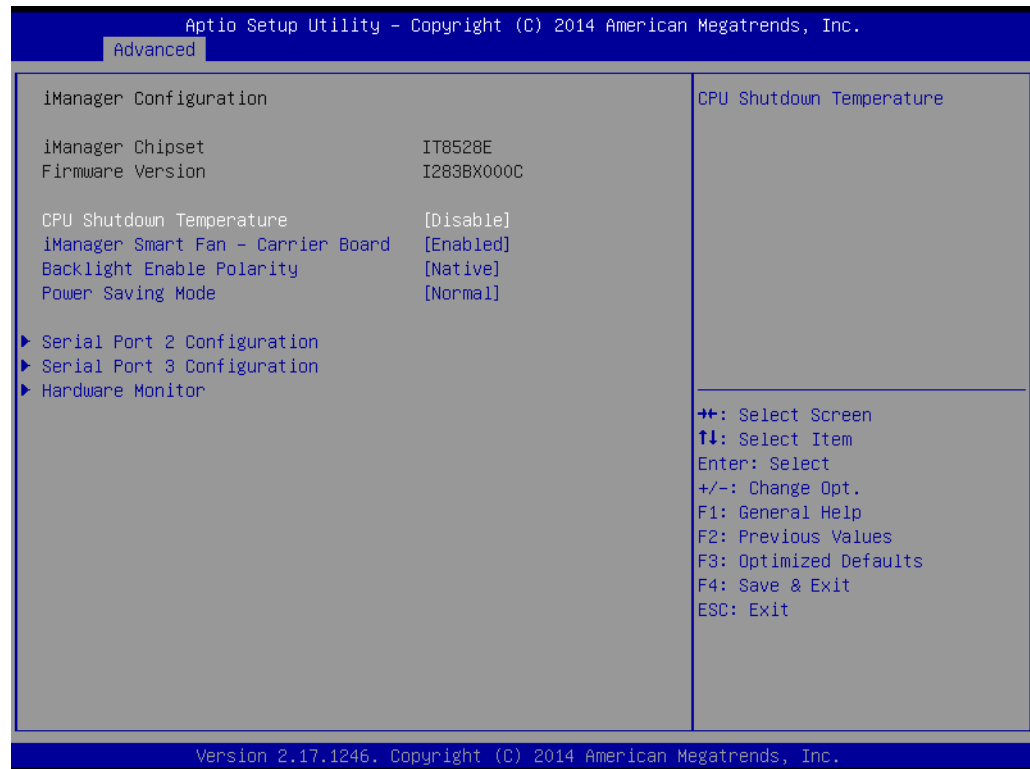

Figure 3.11 iManager Configuration

- **CPU Shutdown Temperature**
This item allows users to select CPU Shutdown Temperature.
- **iManager Smart Fan – Carrier Board**
This item allows users to control iManager Smart function in Carrier Board.
- **Backlight Enable Polarity**
This item allows users to switch backlight enable polarity for Native or Invert.
- **Power Saving Mode**
This item allows users to select Ite8518 Power Saving Mode.
- **Serial Port 2 Configuration**
Set parameter of Serial Port 2.
- **Serial Port 3 Configuration**
Set parameter of Serial Port 3.
- **Hardware Monitor**
This item allows users to monitor hardware status.

3.3.5.1 Serial Port 2 Configuration

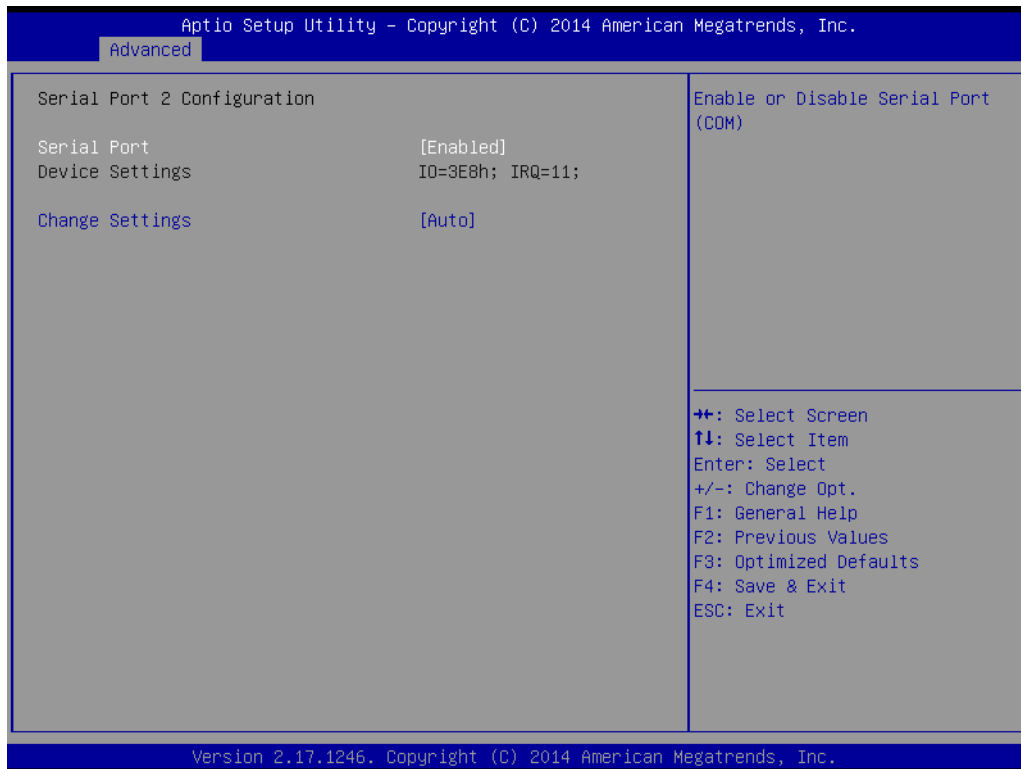

Figure 3.12 Serial Port 2 Configuration

- **Serial Port**
Customer can enable or disable Serial Port (COM).
- **Change settings**
Users can select an optional setting for Serial Port.

3.3.5.2 Serial Port 3 Configuration

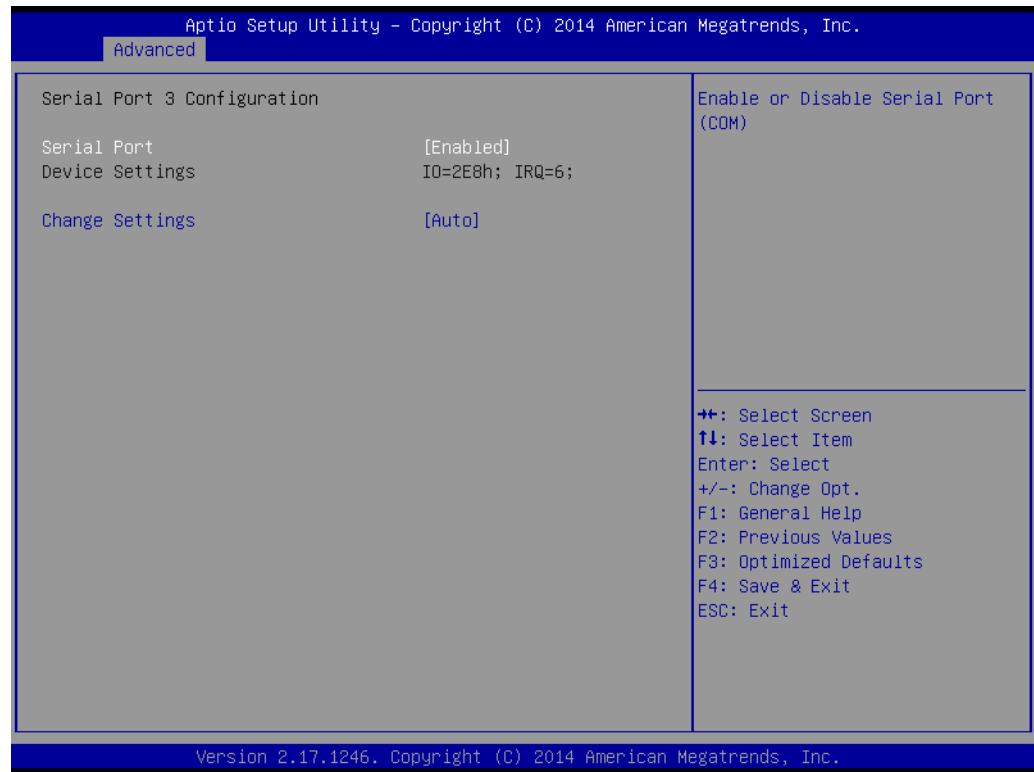

Figure 3.13 Serial Port 3 Configuration

- **Serial Port**
COM Port 3 enables or disables Serial Port (COM).
- **Change settings**
Users can select an optional setting for Serial Port.

3.3.5.3 Hardware Monitor

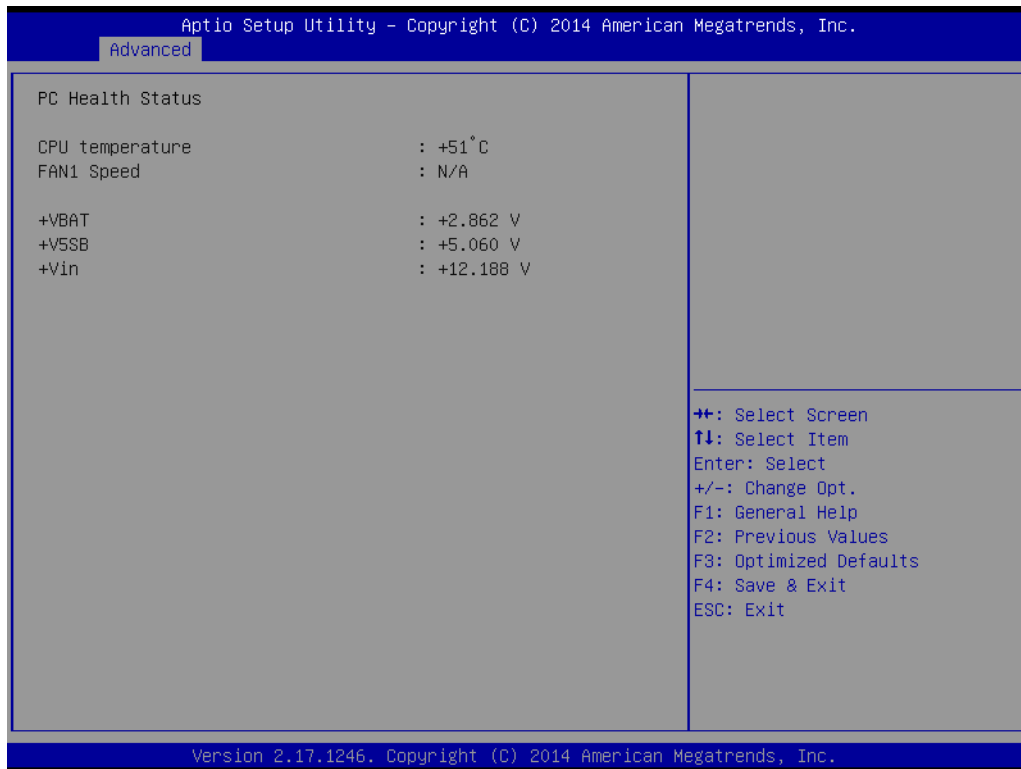

Figure 3.14 Hardware Monitor

3.3.6 Serial Port Console Redirection

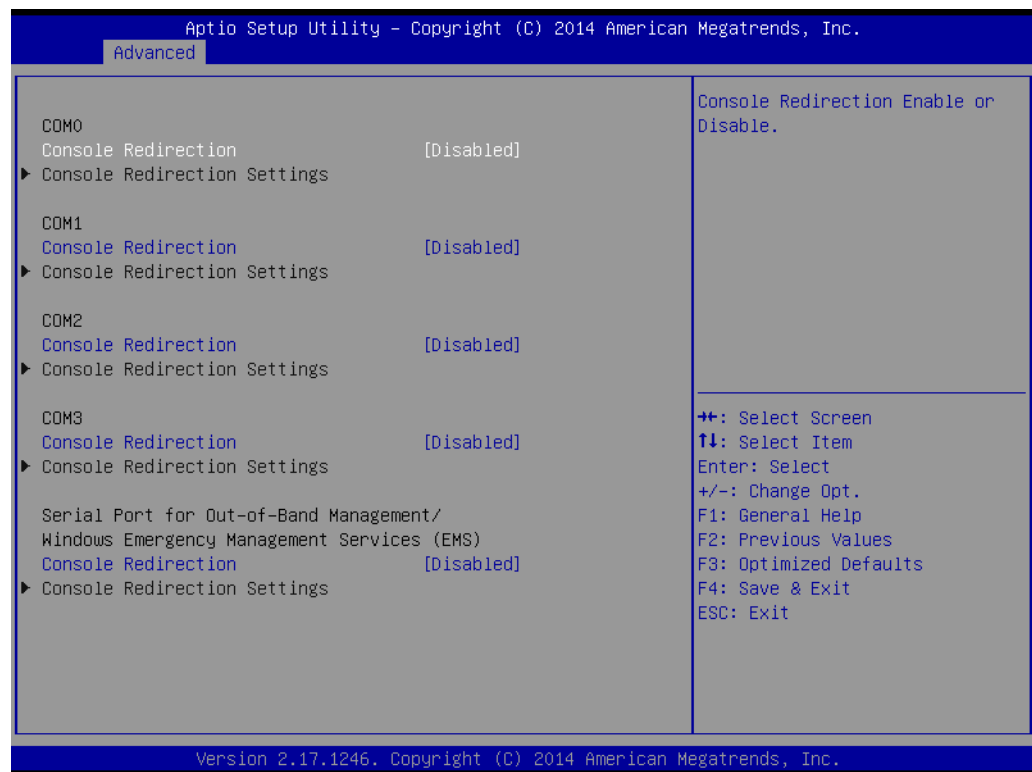

Figure 3.15 Serial Port Console Redirection

- **Legacy Console Redirection Setting**
This item allows users to set Legacy console redirection settings.
- **Console Redirection**
This item allows users to enable or disable console redirection for Microsoft Windows Emergency Management Services (EMS).

3.3.7 CPU Configuration

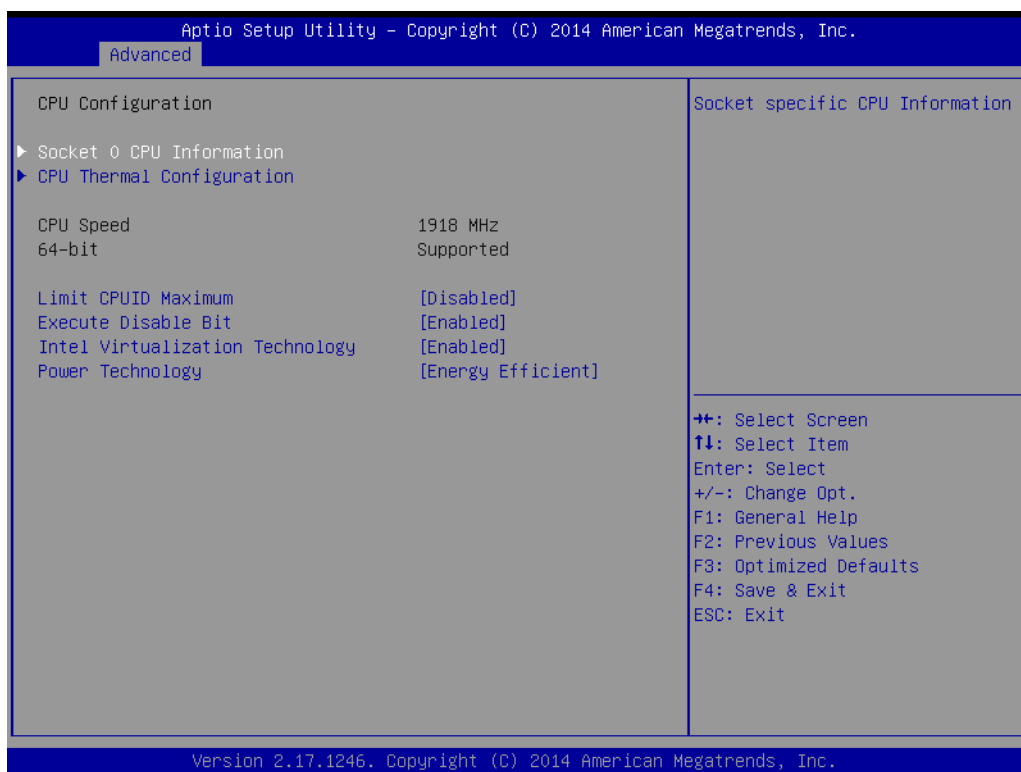

Figure 3.16 CPU Redirection

- **Socket 0 CPU Configuration**
This item allows user to set Socket 0 CPU Configuration.
- **CPU Thermal Configuration**
This item allows user to set CPU Thermal Configuration.
- **Limit CPUID Maximum**
Disabled for Windows XP.
- **Execute Disable Bit**
XD can prevent certain classes of malicious buffer overflow attacks when combined with a supporting OS (Windows Server 2003 SP1, Windows XP SP2, SuSE Linux 9.2, RedHat Enterprise 3 Update 3.).
- **Intel Virtualization Technology**
When enabled, a VMM can utilize the additional hardware capabilities provided by Vanderpool Technology.
- **Power Technology**
This item allows users to enable the power management features.

3.3.7.1 Socket 0 CPU Information

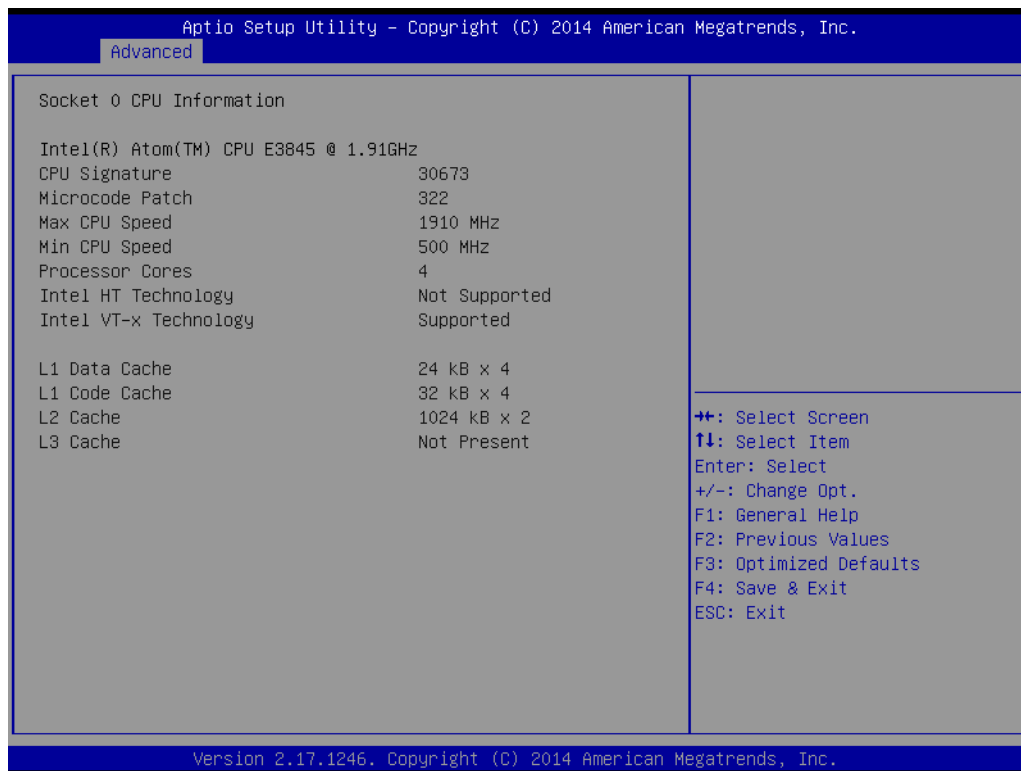

Figure 3.17 Socket 0 CPU Information

3.3.7.2 CPU Thermal Configuration



Figure 3.18 CPU Thermal Configuration

- **DTS**
This item allows users to enable Digital Thermal Sensor.

3.3.8 PPM Configuration

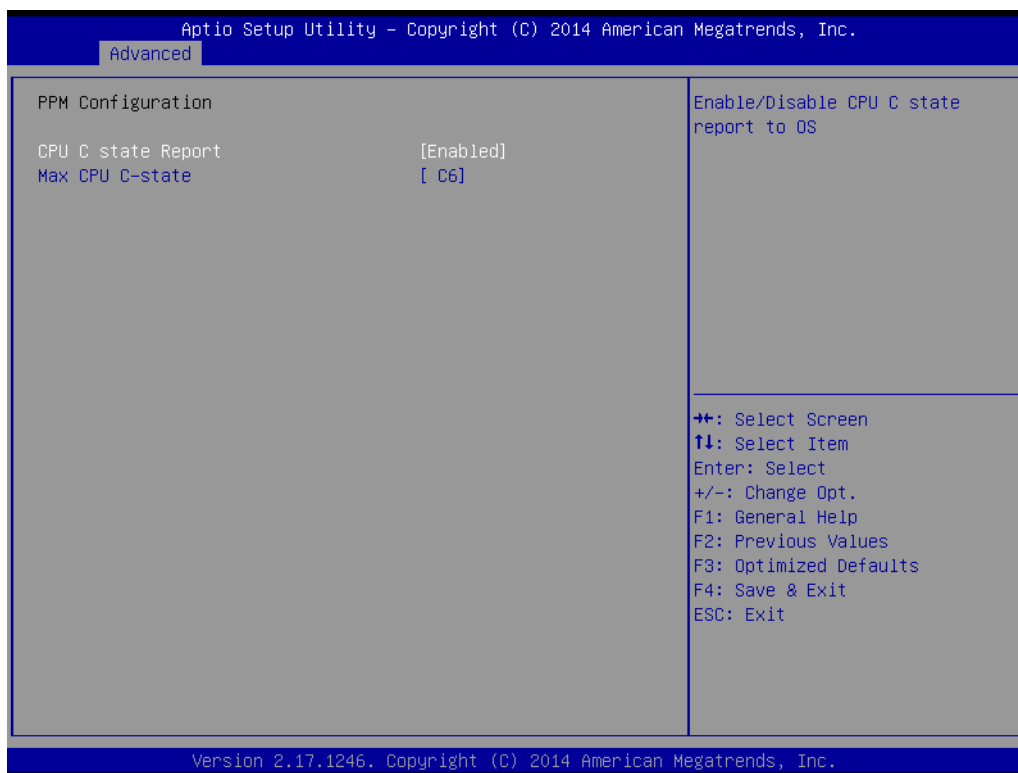

Figure 3.19 PPM Configuration

- **CPU C state Report**
This item allows users to enable CPU C state report to OS.
- **Max CPU C-state**
This option controls Max C state that the processor will support.

3.3.9 IDE Configuration

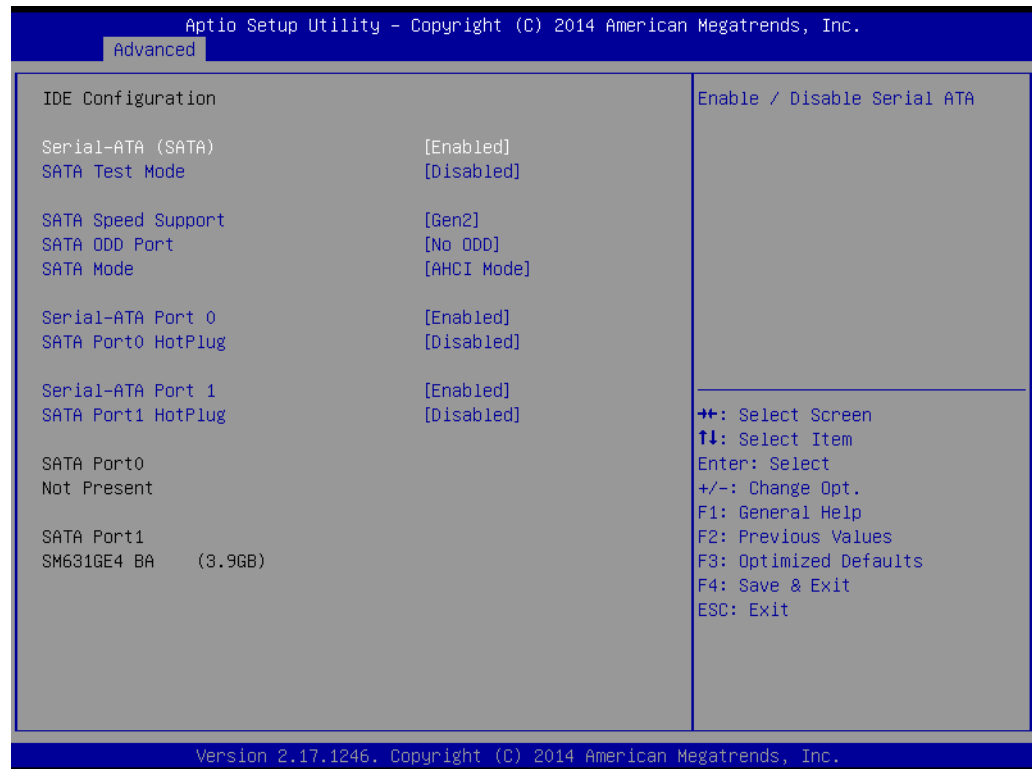

Figure 3.20 IDE Configuration

- **Serial-ATA (SATA)**
This item allows users to enable or disable Serial ATA.
- **SATA Test Mode**
This item allows users to enable or disable SATA Test mode.
- **SATA Speed Support**
This item allows users to select SATA speed support in Gen1 or Gen2.
- **SATA ODD Port**
This item allows users to select SATA ODD Port.
- **SATA Mode**
This item allows users to select IDE/AHCI SATA mode.
- **Serial-ATA Port 0**
This item allows users to enable or disable Serial ATA Port 0.
- **SATA Port0 HotPlug**
This item allows users to enable or disable SATA Port0 Hotplug.
- **Serial-ATA Port 1**
This item allows users to enable or disable Serial ATA Port 1.
- **SATA Port1 HotPlug**
This item allows users to enable or disable SATA Port1 Hotplug.

3.3.10 Network Stack Configuration



Figure 3.21 Network Stack Configuration

- **Network Stack**
This item allows users to enable or disable UEFI Network Stack.

3.3.11 CSM Configuration

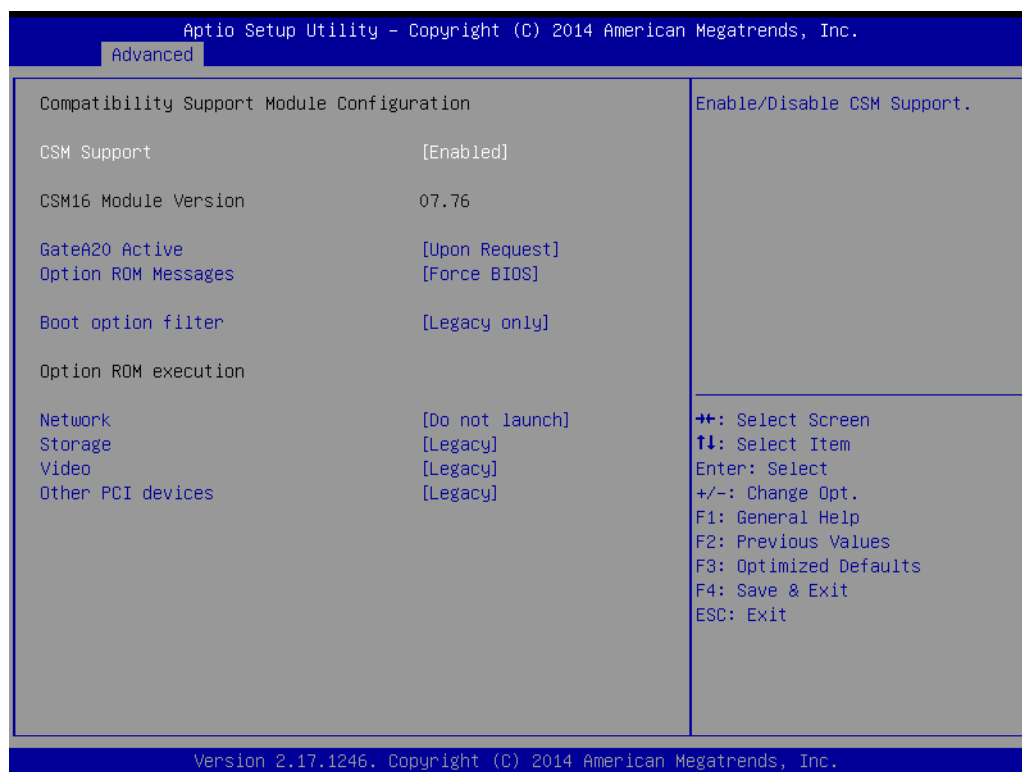

Figure 3.22 CSM Configuration

- **CSM Support**
This item allows users to enable or disable CSM Support.
- **GateA20 Active**
This item allows users to select the timing to active GateA20.
- **Option ROM Messages**
This item allows user to set display mode for Option ROM.
- **Boot option filter**
This option controls Legacy/UEFI ROMs priority.
- **Network**
This item controls the execution of UEFI and Legacy PXE OpROM.
- **Storage**
This item controls the execution of UEFI and Legacy Storage OpROM.
- **Video**
This item controls the execution of UEFI and Legacy Video OpROM.
- **Other PCI devices**
This item determines OpROM execution policy for devices other than Network, Storage, or Video.

3.3.12 USB Configuration



Figure 3.23 USB Configuration

- **LegacyUSB Support**
This item allows users to enable or disable LegacyUSB Support.
- **XHCI Hand-off**
This is a workaround for OS without XHCI hand-off support. The XHCI ownership change should be claimed by XHCI driver.
- **EHCI hand-off**
This is a workaround for OS without EHCI hand-off support. The EHCI ownership change should be claimed by EHCI driver.
- **USB Mass Storage Driver Support**
This item allows users to enable or disable USB Mass Storage Driver Support.
- **USB transfer time-out**
The time-out value for Control, Bulk, and Interrupt transfers.
- **Device reset time-out**
USB mass storage device Start Unit command time-out.
- **Device power-up delay**
Maximum time the device will take before it properly reports itself to the Host Controller. "Auto" uses default value: for a Root port it is 100ms, for 1 Hub port the delay is taken from Hub descriptor.

3.3.13 Security Configuration

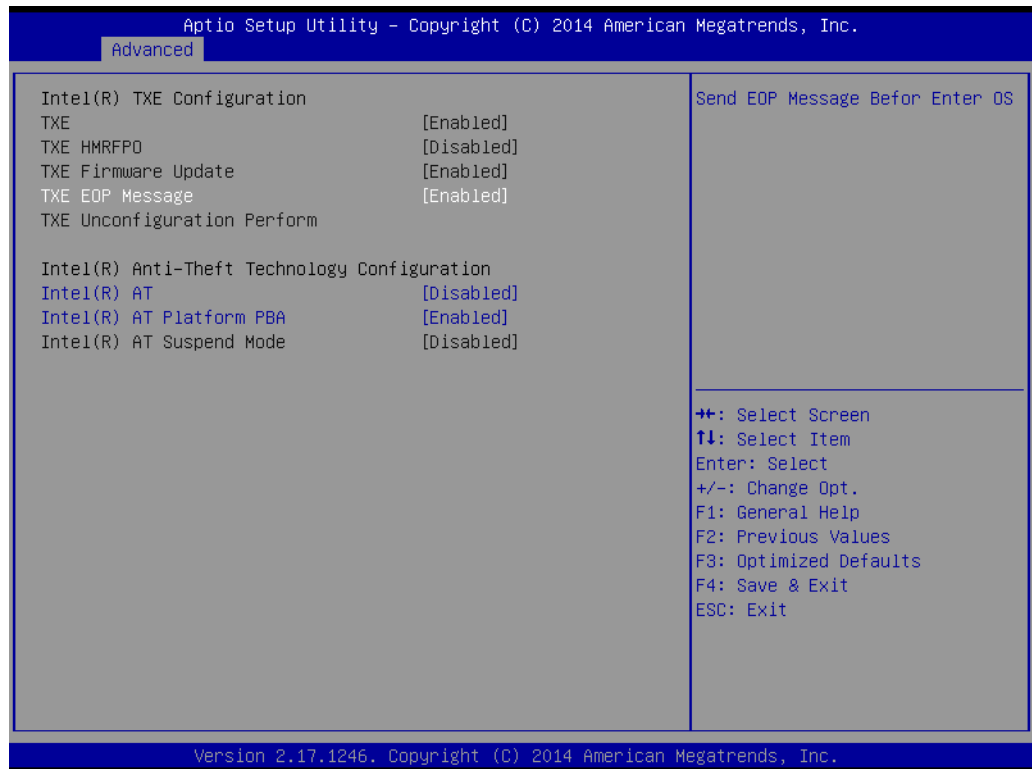

Figure 3.24 Security Configuration

- **TXE**
This item allows users to enable or disable TXE support.
- **TXE HMRFPD**
This item allows users to enable or disable TXE HMRFPD.
- **TXE Firmware Update**
This item allows users to enable or disable TXE Firmware update.
- **TXE EOP Message**
This item allows users to send EOP Message before enter OS.
- **TXE Unconfiguration Perform**
This item allows users to revert TXE settings to factory defaults.
- **Intel(R) AT**
This item allows users to enable/disable BIOS AT Code from running.
- **Intel(R) AT Platform PBA**
This item allows users to enable/disable BIOS AT Code from running.

3.4 Chipset

Select the Chipset tab from the SOM-6867 setup screen to enter the Chipset BIOS Setup screen. You can display a Chipset BIOS Setup option by highlighting it using the <Arrow> keys. All Plug and Play BIOS Setup options are described in this section. The Plug and Play BIOS Setup screen is shown below.

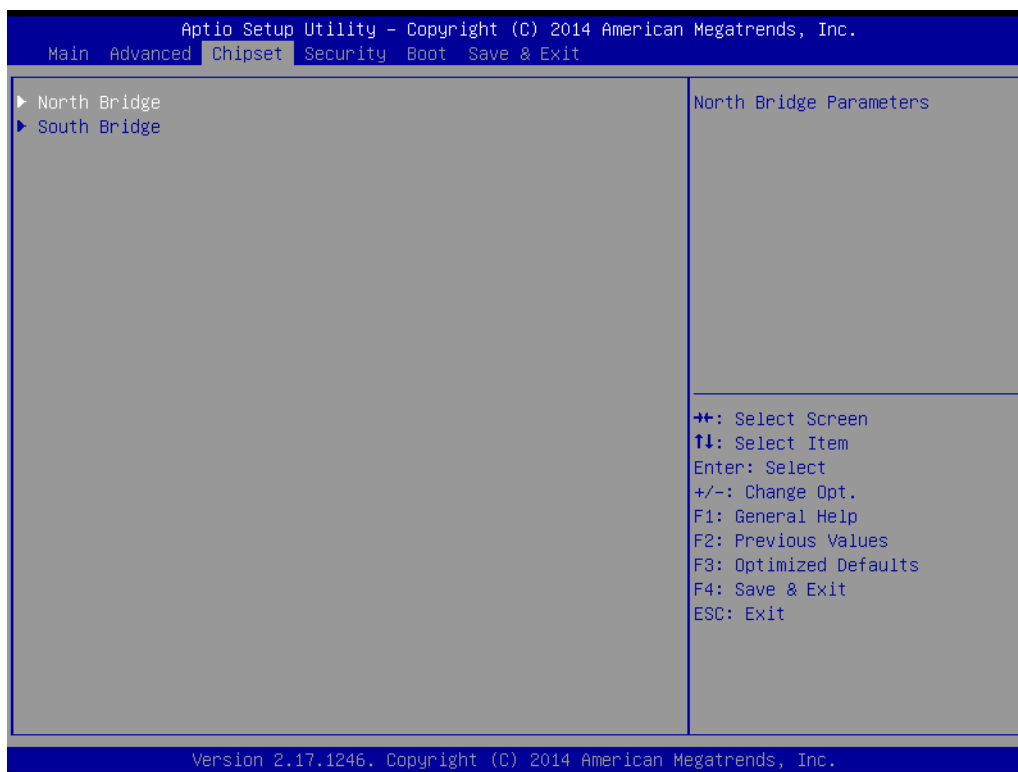

Figure 3.25 Chipset Setup

- **North Bridge**
This item allows users to set North Bridge parameters.
- **South Bridge**
This item allows users to set South bridge parameters.

3.4.1 North Bridge

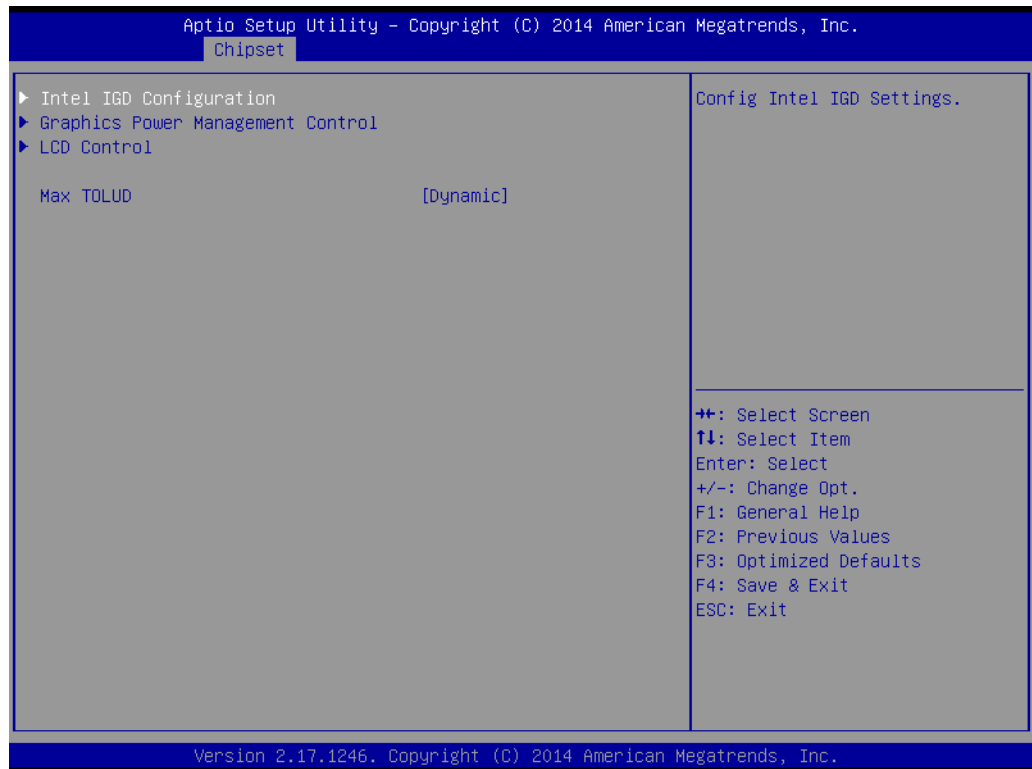

Figure 3.26 North Bridge

- **Intel IGD Configuration**
This item allows users to configure Intel IGD Settings.
- **Graphics Power Management Control**
This item allows users to configure Graphics Power Management Control options.
- **LCD Control**
This item allows users to control LCD setting.
- **MAX TOLUD**
This item allows users to set Maximum value of TOLUD.

3.4.1.1 Intel IGD Configuration

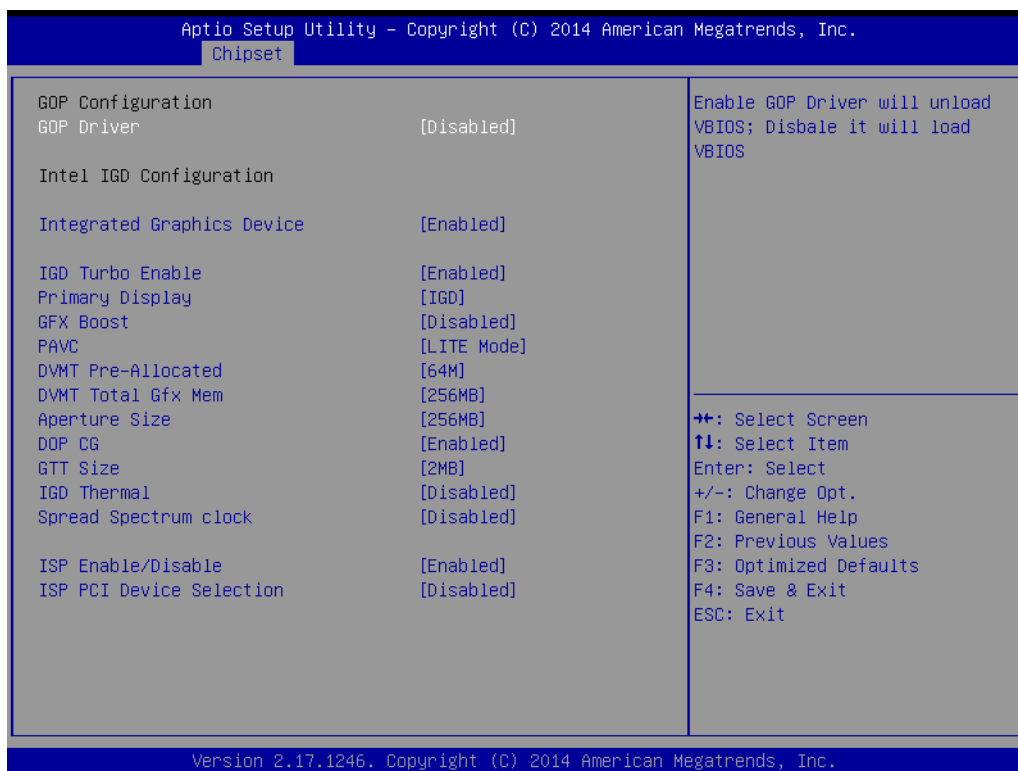

Figure 3.27 Intel IGD Configuration

- **GOP Driver**
This item allows users to enable or disable GOP Driver. Enable GOP driver will unload VBIOS; Disable it will load VBIOS.
- **Integrated Graphics Device**
This item allows users to enable or disable Integrated Graphics Device.
- **IGD Turbo Enable**
This item allows users to enable or disable IGD Turbo.
- **Primary Display**
This item allows users to select which of IGD/PCI Graphics device should be primary Display.
- **GFX Boost**
This item allows users to enable or disable GFX Boost
- **PAVC**
This item allows users to enable or disable Protected Audio Video Control.
- **DVMT Pre-Allocated**
This item allows users to select DVMT 5.0 Pre-Allocated (Fixed) Graphics Memory size used by the internal Graphics Device.
- **DVMT Total Gfx Mem**
This item allows users to select DVMT 5.0 Total Graphics Memory size used by the internal Graphics Device.
- **Aperture Size**
This item allows users to select Aperture Size.
- **DOP CG**
This item allows users to enable/disable DOP Clock Gating.
- **GTT Size**
This item allows users to select GTT Size.

- **IGD Thermal**
This item allows users to enable/disable IGD Thermal.
- **Spread Spectrum clock**
This item allows users to enable/disable Spread Spectrum clock.
- **ISP Enable/Disable**
This item allows users to enable/disable ISP PCI Device Selection.
- **ISP PCI Device Enable/Disable**
Default ISP is PCI B0D2F0 for Window Boot. Linux Boot to select B0D3G0.

3.4.1.2 Graphics Power Management Control

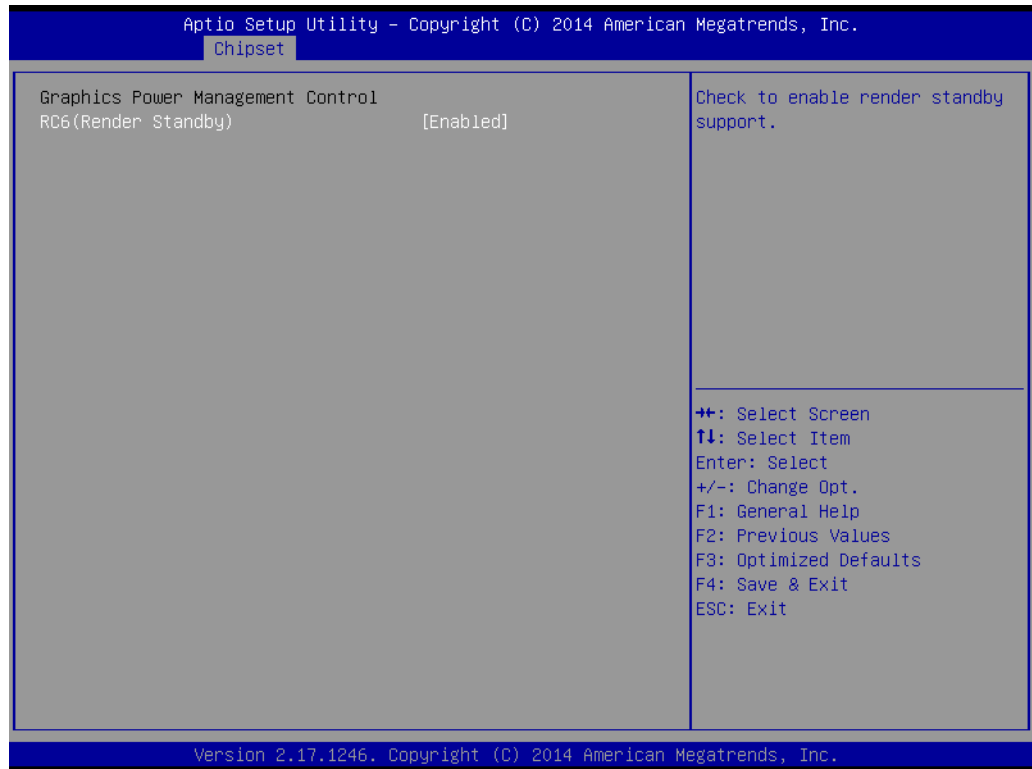

Figure 3.28 Graphics Power Management Control

- **RC6 (Render Standby)**
This item allows users to enable/disable render standby support.

3.4.1.3 LCD Control

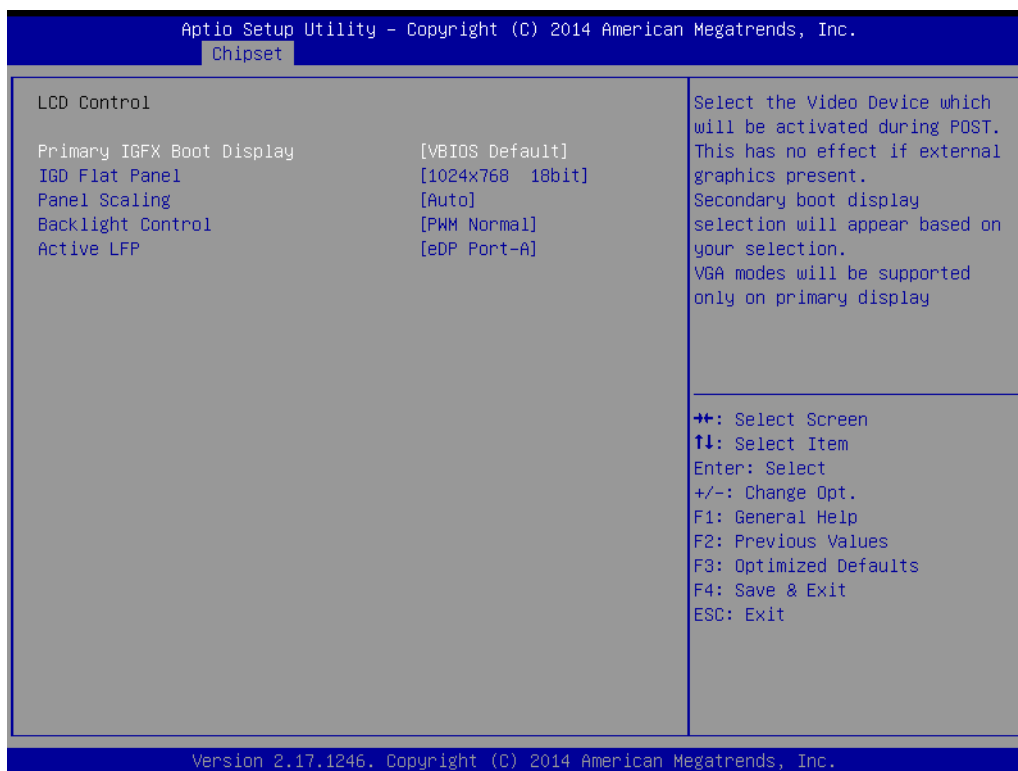

Figure 3.29 LCD Control

- **Primary IGFX Boot Display**
Select the Video Device which will be activated during POST. This has no effect if external graphics present.
- **IGD Flat panel**
This item allows users to select IGD Flat panel options.
- **Panel Scaling**
This item allows users to select the LCD panel scaling option used by the Internal Graphics Device.
- **Backlight Control**
This item allows users to select back light control setting.
- **Active LFP**
This item allows users to select “No LVDS” or “eDP Port-A”.

3.4.2 South Bridge

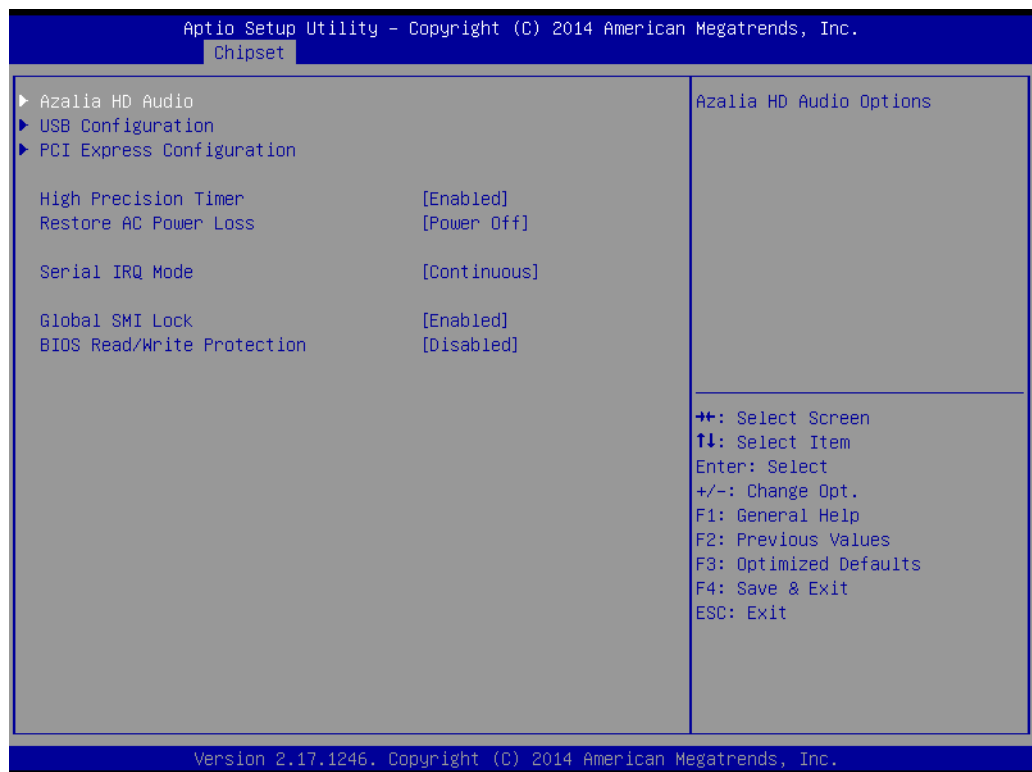

Figure 3.30 South Bridge

- **Azalia HD Audio**
This item allows users to configure Azalia HD Audio Options.
- **USB Configuration**
This item allows users to configure USB Configuration settings.
- **PCI Express Configuration**
This item allows users to configure PCI Express Configuration settings.
- **High Precision Timer**
This item allows users to enable/disable the High Precision Event Timer.
- **Restore AC Power Loss**
This item allows users to select AC power state when power is re-applied after a power failure.
- **Serial IRQ Mode**
This item allows users to configure Serial IRQ Mode.
- **Global SMI Lock**
This item allows users to enable/disable SMI Lock.
- **BIOS Read/Write Protection**
This item allows users to enable/disable BIOS SPI region read/write protect.

3.4.2.1 Azalia HD Audio

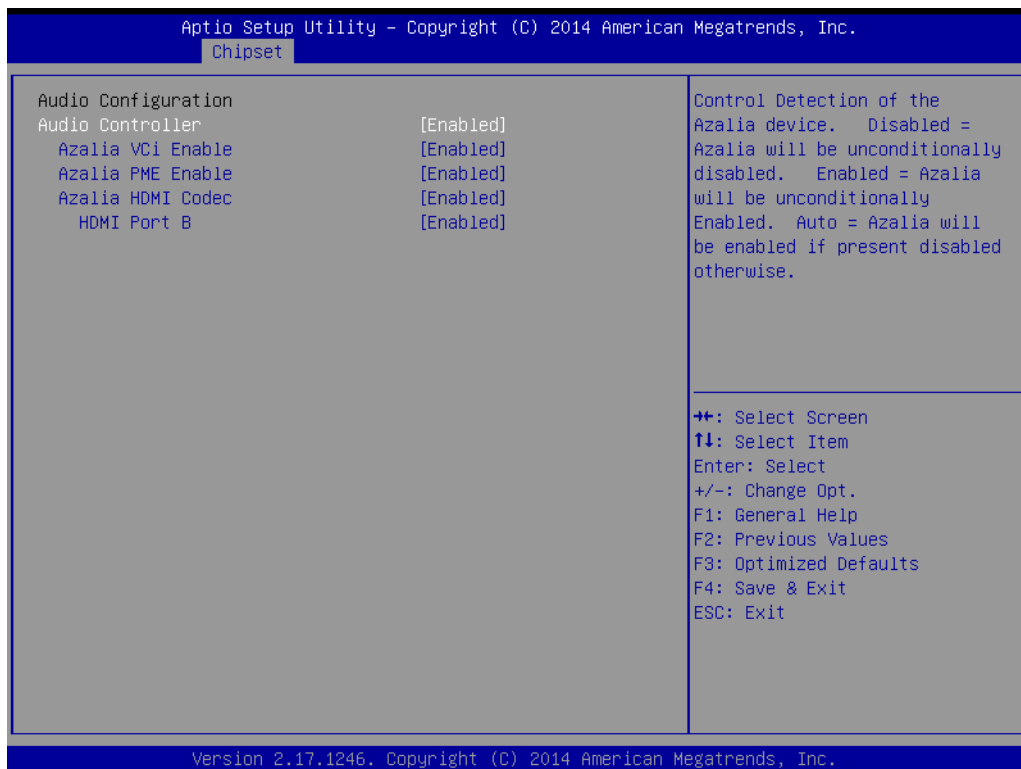

Figure 3.31 Azalia HD Audio

- **Audio Controller**
This item allows users to control Detection of the Azalia Device.
- **Audio VCI Controller**
This item allows users to enable/disable Virtual Channel 1 of Audio Controller.
- **Audio PME Controller**
This item allows users to enable/disable Power Management capability of Audio Controller.
- **Audio HDMI Codec**
This item allows users to enable/disable internal HDMI codec for Azalia.
 - **HDMI Port B**
This item allows users to enable/disable HDMI Port B.

3.4.2.2 USB Configuration

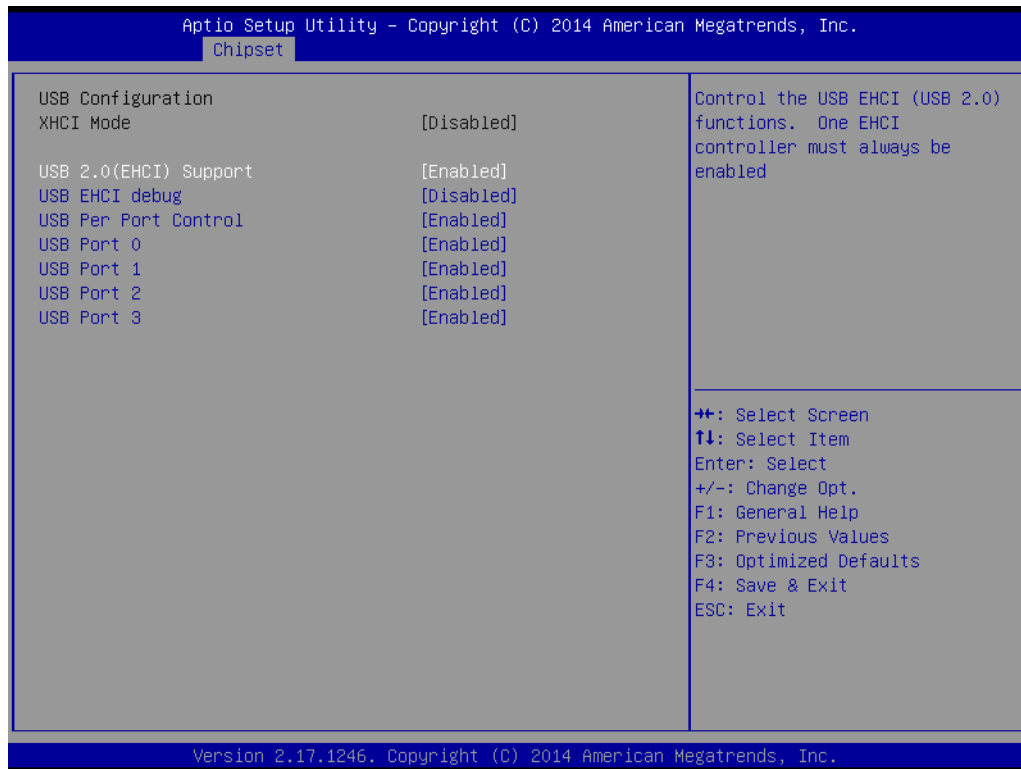

Figure 3.32 USB Configuration

- **USB 2.0 (EHCI) Support**
This item allows users to control the USB EHCI (USB 2.0) functions. One EHCI controller must always be enabled.
- **USB EHCI debug**
This item allows users to enable/disable PCH EHCI debug capability.
- **USB Per Port Control**
This item allows users to control each of the USB ports (0~3).
- **USB Port 0**
This item allows users to enable/disable USB Port 0.
- **USB Port 1**
This item allows users to enable/disable USB Port 1.
- **USB Port 2**
This item allows users to enable/disable USB Port 2.
- **USB Port 3**
This item allows users to enable/disable USB Port 3.

3.4.2.3 PCI Express Configuration



Figure 3.33 PCI Express Configuration

- **PCI Express Port 0**
This item allows users to enable/disable PCI Express Port 0 in the Chipset.
 - **Hot Plug**
This item allows users to enable/disable PCI Express Hot Plug.
 - **Speed**
This item allows users to configure PCIe Port Speed.
- **PCI Express Port 1**
This item allows users to enable/disable PCI Express Port 1 in the Chipset.
 - **Hot Plug**
This item allows users to enable/disable PCI Express Hot Plug.
 - **Speed**
This item allows users to configure PCIe Port Speed.
- **PCI Express Port 2**
This item allows users to enable/disable PCI Express Port 2 in the Chipset.
 - **Hot Plug**
This item allows users to enable/disable PCI Express Hot Plug.
 - **Speed**
This item allows users to configure PCIe Port Speed.
- **PCI Express Port 3 / LAN**
This item allows users to enable/disable PCI Express Port 3 or onboard LAN.
 - **Hot Plug**
This item allows users to enable/disable PCI Express Hot Plug.
 - **Speed**
This item allows users to configure PCIe Port Speed.

3.5 Security

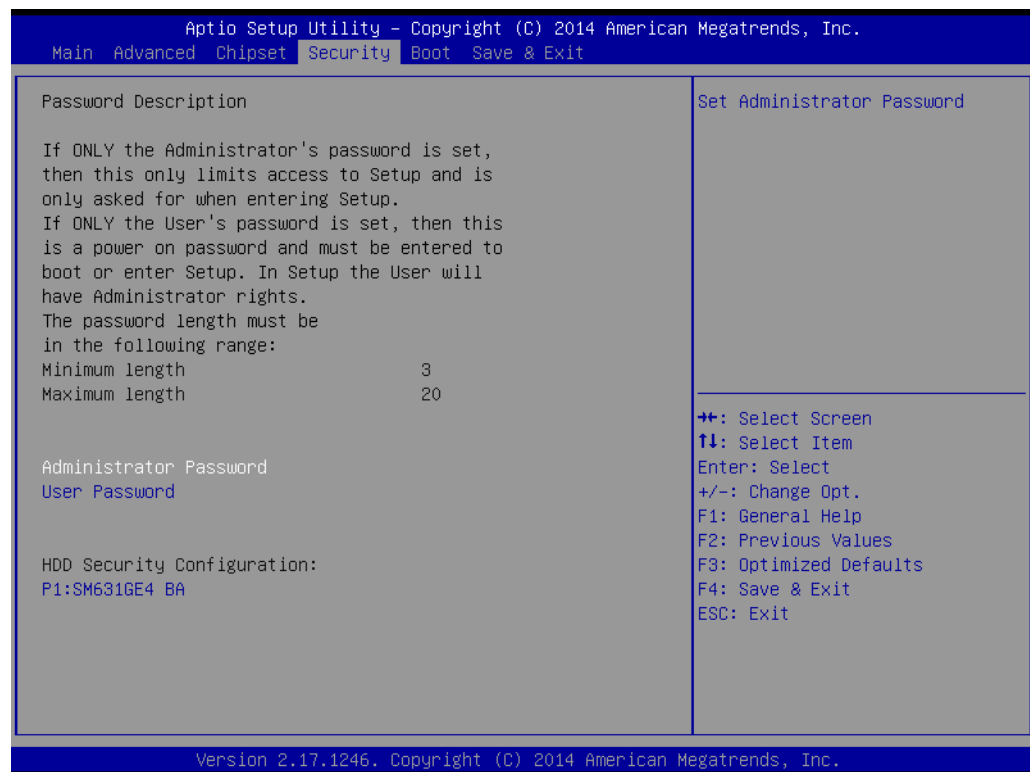

Figure 3.34 Security

- **Administrator Password**
This item allows users to set Administrator Password.
- **User Password**
This item allows users to set User Password.
- **P1: SM611GX8**
HDD Security Configuration for selected driver.
(This item will be shown if onboard SSD is available)

3.6 Boot

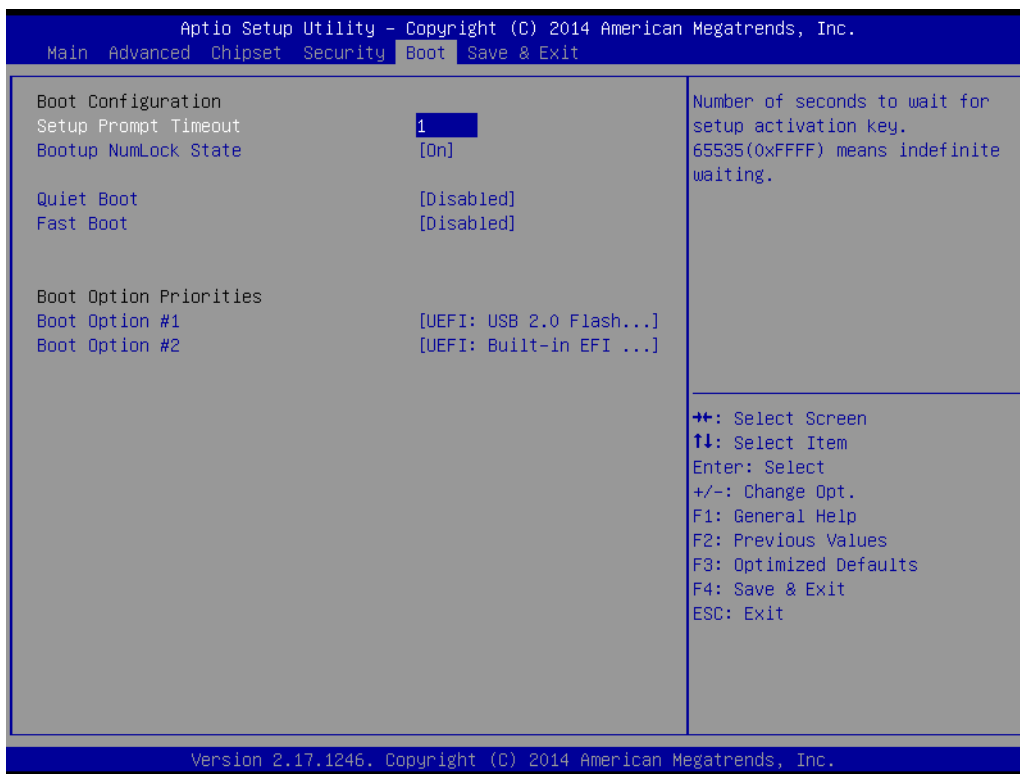

Figure 3.35 Security

- **Setup Prompt Timeout**
This item allows users to select the number of seconds to wait for setup activation key.
- **Bootup NumLock State**
This item allows users to select the Power-on state for Numlock.
- **Quiet Boot**
This item allows users to enable or disable Quiet Boot option.
- **Fast Boot**
This item allows users to enable or disable boot with initialization of a minimal set of devices required to launch active boot option. Has no effect for BBS boot options.
- **Boot Option Priority**
This item allows users to set the system boot order.

3.7 Save & Exit



Figure 3.36 Save & Exit

3.7.1 Save Changes and Exit

When users have completed system configuration, select this option to save changes, exit BIOS setup menu and reboot the computer if necessary to take effect all system configuration parameters.

3.7.2 Discard Changes and Exit

Select this option to quit Setup without making any permanent changes to the system configuration.

3.7.3 Save Changes and Reset

When users have completed system configuration, select this option to save changes, exit BIOS setup menu and reboot the computer to take effect all system configuration parameters.

3.7.4 Discard Changes and Reset

Select this option to quit Setup without making any permanent changes to the system configuration and reboot the computer.

3.7.5 Save Changes

When users have completed system configuration, select this option to save changes without exit BIOS setup menu.

3.7.6 Discard Changes

Select this option to discard any current changes and load previous system configuration.

3.7.7 Restore Defaults

The SOM-6867 automatically configures all setup items to optimal settings when users select this option. Optimal Defaults are designed for maximum system performance, but may not work best for all computer applications. In particular, do not use the Optimal Defaults if the user's computer is experiencing system configuration problems.

3.7.8 Save as User Defaults

When users have completed system configuration, select this option to save changes as user defaults without exit BIOS setup menu.

3.7.9 Restore User Defaults

The users can select this option to restore user defaults.

3.7.10 Launch EFI Shell from filesystem device

Attempts to Launch EFI Shell application from one of the available file system devices.

3.8 EnableUSB 3.0

To enableUSB 3.0, please follow below procedure to enableUSB 3.0(XHCI) driver.

1. Go to **Chipset -> South Bridge ->USB Configuration**

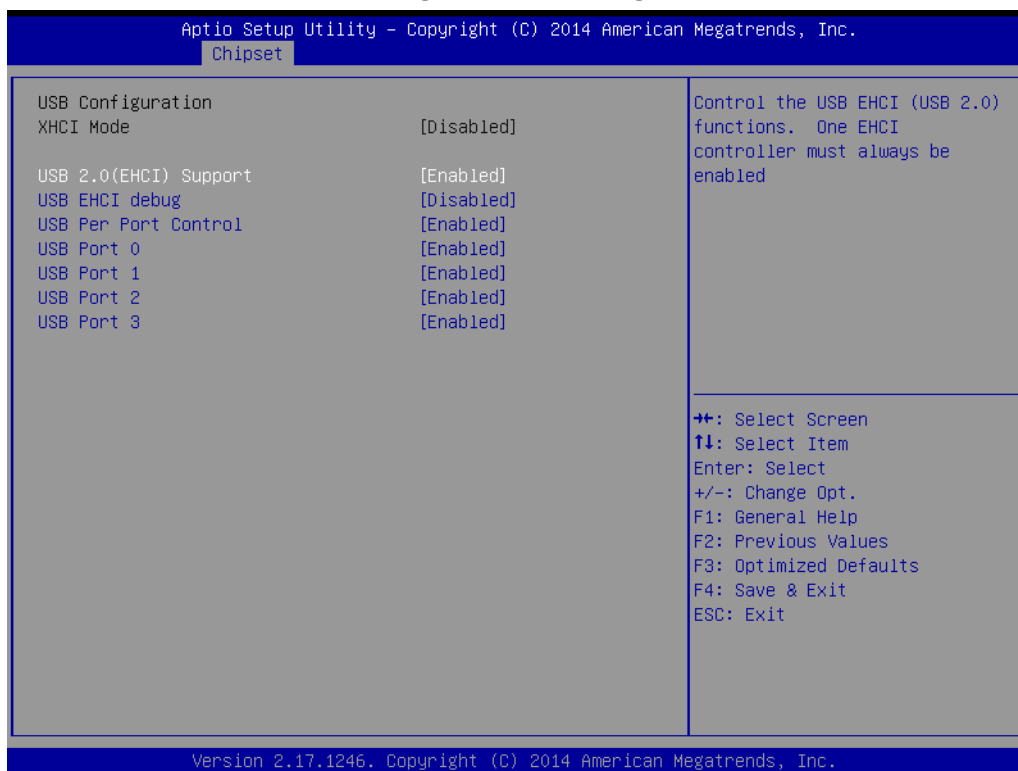

2. Select “Disable” in USB 2.0(EHCI) Support

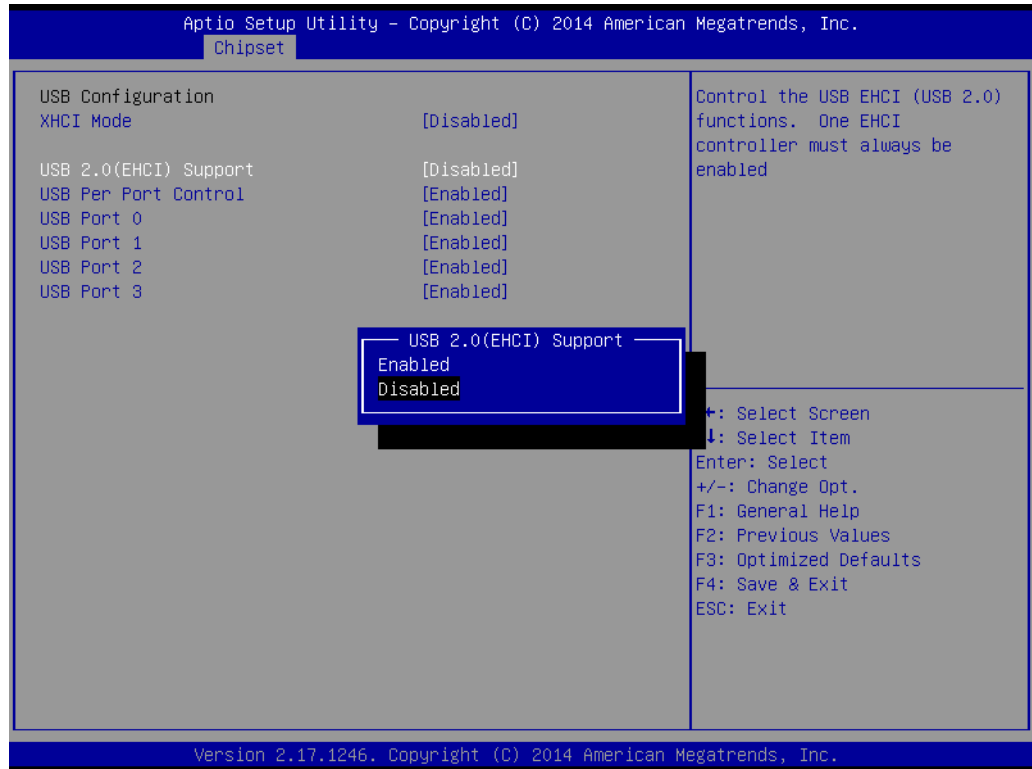

3. Select “Enable” in XHCI Mode

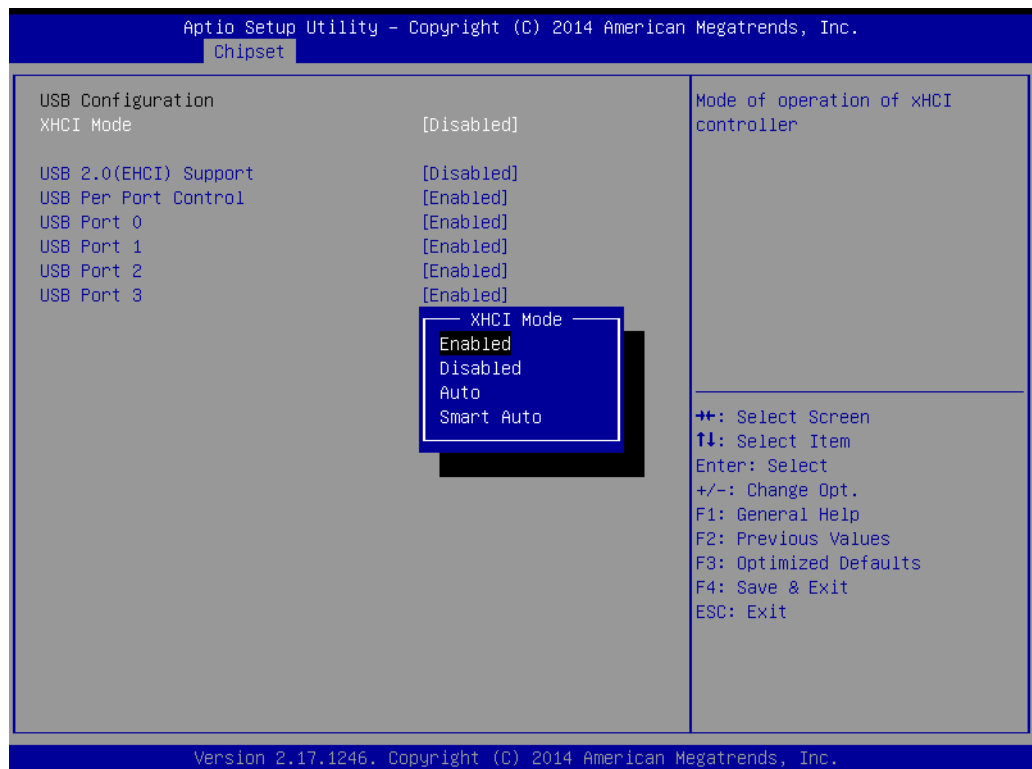

Enable: Enable XHCI Mode

Disable: Disable XHCI Mode

Auto: System will depend on previous boot setting in OS to enable/disable XHCI.

Smart Auto: System will depend on previous boot setting in POST and OS to enable/disable XHCI.

3.9 BIOS/FW Supported Matrix

Intel has defined BIOS/FW Supported Matrix as table underneath. Standard BIOS default is configured as legacy environment. If user wants to set EFI environment, please refer to chapter 3.9.1.

Operating System	BIOS Environment	VBIOS FW
Windows/WES 7	Legacy	VBIOS
Windows Embedded Compact7	(Default)	(Default)
Windows/WES 8		
Android	EFI	GOP
Linux (Fedora 18/Yocto 18)		

* SOM-6867 standard product is configured with 64bis BIOS (Windows 7)

Chapter 4

S/W Introduction & Installation

Sections include:

- S/W Introduction
- Driver Installation
- Advantech iManger

4.1 S/W Introduction

The mission of Advantech Embedded Software Services is to "Enhance quality of life with Advantech platforms and Microsoft Windows embedded technology." We enable Windows Embedded software products on Advantech platforms to more effectively support the embedded computing community. Customers are freed from the hassle of dealing with multiple vendors (Hardware suppliers, System integrators, Embedded OS distributor) for projects. Our goal is to make Windows Embedded Software solutions easily and widely available to the embedded computing community.

4.2 Driver Installation

The Intel Chipset Software Installation (CSI) utility installs the Windows INF files that outline to the operating system how the chipset components will be configured.

4.2.1 Windows Driver Setup

To install the drivers on a windows-based operation system, please connect to internet and browse the website <http://support.advantech.com.tw> and download the drivers that you want to install and follow Driver Setup instructions to complete the installation.

4.2.2 Other OS

To install the drivers for Other Windows OS or Linux, please connect to internet and browse the website <http://support.advantech.com.tw> to download the setup file.

4.3 Advantech iManager

Advantech's platforms come equipped with iManager, a micro controller that provides embedded features for system integrators. Embedded features have been moved from the OS/BIOS level to the board level, to increase reliability and simplify integration. iManager runs whether the operating system is running or not; it can count the boot times and running hours of the device, monitor device health, and provide an advanced watchdog to handle errors just as they happen. iManager also comes with a secure & encrypted EEPROM for storing important security key or other customer define information. All the embedded functions are configured through API and provide corresponding utilities to demonstrate. These APIs comply with PICMG EAPI (Embedded Application Programmable Interface) specification and unify in the same structures. It makes these embedded features easier to integrate, speed up developing schedule, and provide the customer's software continuity while upgrade hardware. For more details of how to use the APIs and utilities, please refer to Advantech iManager 2.0 Software API User Manual.

Control



GPIO

General Purpose Input/Output is a flexible parallel interface that allows a variety of custom connections. It allows users to monitor the level of signal input or set the output status to switch on/off a device. Our API also provides Programmable GPIO, which allows developers to dynamically set the GPIO input or output status.



SMBus

SMBus is the System Management Bus defined by Intel® Corporation in 1995. It is used in personal computers and servers for low-speed system management communications. The SMBus API allows a developer to interface a embedded system environment and transfer serial messages using the SMBus protocols, allowing multiple simultaneous device control.



I2C

I2C is a bi-directional two wire bus that was developed by Philips for use in their televisions in the 1980s. The I2C API allows a developer to interface with an embedded system environment and transfer serial messages using the I2C protocols, allowing multiple simultaneous device control.

Display



Brightness Control

The Brightness Control API allows a developer to interface with an embedded device to easily control brightness.



Backlight

The Backlight API allows a developer to control the backlight (screen) on/off in an embedded device.

Monitor



Watchdog

A watchdog timer (WDT) is a device that performs a specific operation after a certain period of time if something goes wrong and the system does not recover on its own. A watchdog timer can be programmed to perform a warm boot (restarting the system) after a certain number of seconds.



Hardware Monitor

The Hardware Monitor (HWM) API is a system health supervision API that inspects certain condition indexes, such as fan speed, temperature and voltage.



Hardware Control

The Hardware Control API allows developers to set the PWM (Pulse Width Modulation) value to adjust fan speed or other devices; it can also be used to adjust the LCD brightness.

Power Saving



CPU Speed

Make use of Intel SpeedStep technology to reduce power power consumption. The system will automatically adjust the CPU Speed depending on system loading.



System Throttling

Refers to a series of methods for reducing power consumption in computers by lowering the clock frequency. These APIs allow the user to lower the clock from 87.5% to 12.5%.

Appendix **A**

Pin Assignment

This appendix gives you the information about the hardware pin assignment of the SOM-6867 CPU System on Module

Sections include:

- SOM-6867 Type 6 Pin Assignment

A.1 SOM-6867 Type 6 Pin Assignment

This section gives SOM-6867 pin assignments on COM Express connectors which are compliant with COMR.0 R2.1 Type 6 pin-out definitions. For more details about how to use these pins and getting the design reference, please contact Advantech for design guide, checklist, reference schematic, and other hardware/software support.

SOM-6867 Row A,B			
A1	GND (FIXED)	B1	GND (FIXED)
A2	GBE0_MDI3-	B2	GBE0_ACT#
A3	GBE0_MDI3+	B3	LPC_FRAME#
A4	GBE0_LINK100#	B4	LPC_AD0
A5	GBE0_LINK1000#	B5	LPC_AD1
A6	GBE0_MDI2-	B6	LPC_AD2
A7	GBE0_MDI2+	B7	LPC_AD3
A8	GBE0_LINK#	B8	N/A
A9	GBE0_MDI1-	B9	N/A
A10	GBE0_MDI1+	B10	LPC_CLK
A11	GND (FIXED)	B11	GND (FIXED)
A12	GBE0_MDI0-	B12	PWRBTN#
A13	GBE0_MDI0+	B13	SMB_CK
A14	N/A	B14	SMB_DAT
A15	SUS_S3#	B15	SMB_ALERT#
A16	SATA0_TX+	B16	SATA1_TX+
A17	SATA0_TX-	B17	SATA1_TX-
A18	SUS_S4#	B18	SUS_STAT#
A19	SATA0_RX+	B19	SATA1_RX+
A20	SATA0_RX-	B20	SATA1_RX-
A21	GND (FIXED)	B21	GND (FIXED)
A22	N/A	B22	N/A
A23	N/A	B23	N/A
A24	SUS_S4#	B24	PWR_OK
A25	N/A	B25	N/A
A26	N/A	B26	N/A
A27	BATLOW#	B27	WDT
A28	(S)SATA_ACT#	B28	N/A
A29	HDA_SYNC	B29	HDA_SDIN1
A30	HDA_RST#	B30	HDA_SDIN0
A31	GND (FIXED)	B31	GND (FIXED)
A32	HDA_BITCLK	B32	SPKR
A33	HDA_SDOOUT	B33	I2C_CK
A34	BIOS_DIS0#	B34	I2C_DAT
A35	THRMTRIP#	B35	THRM#
A36	USB6-	B36	USB7-
A37	USB6+	B37	USB7+
A38	USB_6_7_OC#	B38	USB_4_5_OC#
A39	USB4-	B39	USB5-
A40	USB4+	B40	USB5+

A41	GND (FIXED)	B41	GND (FIXED)
A42	USB2-	B42	USB3-
A43	USB2+	B43	USB3+
A44	USB_2_3_OC#	B44	USB_0_1_OC#
A45	USB0-	B45	USB1-
A46	USB0+	B46	USB1+
A47	VCC_RTC	B47	EXCD1_PERST#
A48	EXCD0_PERST#	B48	EXCD1_CPPE#
A49	EXCD0_CPPE#	B49	SYS_RESET#
A50	LPC_SERIRQ	B50	CB_RESET#
A51	GND (FIXED)	B51	GND (FIXED)
A52	N/A	B52	N/A
A53	N/A	B53	N/A
A54	GPI0	B54	GPO1
A55	N/A	B55	N/A
A56	N/A	B56	N/A
A57	GND	B57	GPO2
A58	PCIE_TX3+ (Option)	B58	PCIE_RX3+ (Option)
A59	PCIE_TX3- (Option)	B59	PCIE_RX3- (Option)
A60	GND (FIXED)	B60	GND (FIXED)
A61	PCIE_TX2+	B61	PCIE_RX2+
A62	PCIE_TX2-	B62	PCIE_RX2-
A63	GPI1	B63	GPO3
A64	PCIE_TX1+	B64	PCIE_RX1+
A65	PCIE_TX1-	B65	PCIE_RX1-
A66	GND	B66	WAKE0#
A67	GPI2	B67	WAKE1#
A68	PCIE_TX0+	B68	PCIE_RX0+
A69	PCIE_TX0-	B69	PCIE_RX0-
A70	GND (FIXED)	B70	GND (FIXED)
A71	LVDS_A0+	B71	LVDS_B0+
A72	LVDS_A0-	B72	LVDS_B0-
A73	LVDS_A1+	B73	LVDS_B1+
A74	LVDS_A1-	B74	LVDS_B1-
A75	LVDS_A2+	B75	LVDS_B2+
A76	LVDS_A2-	B76	LVDS_B2-
A77	LVDS_VDD_EN	B77	LVDS_B3+
A78	LVDS_A3+	B78	LVDS_B3-
A79	LVDS_A3-	B79	LVDS_BKLT_EN
A80	GND (FIXED)	B80	GND (FIXED)
A81	LVDS_A_CK+	B81	LVDS_B_CK+
A82	LVDS_A_CK-	B82	LVDS_B_CK-
A83	LVDS_I2C_CK	B83	LVDS_BKLT_CTRL
A84	LVDS_I2C_DAT	B84	VCC_5V_SBY
A85	GPI3	B85	VCC_5V_SBY
A86	N/A	B86	VCC_5V_SBY
A87	N/A	B87	VCC_5V_SBY
A88	PCIE_CLK_REF+	B88	BIOS_DIS1#

A89	PCIE_CLK_REF-	B89	VGA_RED
A90	GND (FIXED)	B90	GND (FIXED)
A91	SPI_POWER	B91	VGA_GRN
A92	SPI_MISO	B92	VGA_BLU
A93	GPO0	B93	VGA_HSYNC
A94	SPI_CLK	B94	VGA_VSYNC
A95	SPI_MOSI	B95	VGA_I2C_CK
A96	TPM_PP	B96	VGA_I2C_DAT
A97	TYPE10#	B97	SPI_CS#
A98	SER0_TX	B98	RSVD
A99	SER0_RX	B99	RSVD
A100	GND (FIXED)	B100	GND (FIXED)
A101	SER1_TX	B101	FAN_PWMOUT
A102	SER1_RX	B102	FAN_TACHIN
A103	LID#	B103	SLEEP#
A104	VCC_12V	B104	VCC_12V
A105	VCC_12V	B105	VCC_12V
A106	VCC_12V	B106	VCC_12V
A107	VCC_12V	B107	VCC_12V
A108	VCC_12V	B108	VCC_12V
A109	VCC_12V	B109	VCC_12V
A110	GND (FIXED)	B110	GND (FIXED)

SOM-6867 Row C,D

C1	GND (FIXED)	D1	GND (FIXED)
C2	GND	D2	GND
C3	USB_SSRX0-	D3	USB_SSTX0-
C4	USB_SSRX0+	D4	USB_SSTX0+
C5	GND	D5	GND
C6	N/A	D6	N/A
C7	N/A	D7	N/A
C8	GND	D8	GND
C9	N/A	D9	N/A
C10	N/A	D10	N/A
C11	GND (FIXED)	D11	GND (FIXED)
C12	N/A	D12	N/A
C13	N/A	D13	N/A
C14	GND	D14	GND
C15	N/A	D15	DDI1_CTRLCLK_AUX+
C16	N/A	D16	DDI1_CTRLDATA_AUX-
C17	RSVD	D17	RSVD
C18	RSVD	D18	RSVD
C19	N/A	D19	N/A
C20	N/A	D20	N/A
C21	GND (FIXED)	D21	GND (FIXED)
C22	N/A	D22	N/A
C23	N/A	D23	N/A
C24	DDI1_HPD	D24	RSVD

C25	N/A	D25	RSVD
C26	N/A	D26	DDI1_PAIR0+
C27	RSVD	D27	DDI1_PAIR0-
C28	RSVD	D28	RSVD
C29	N/A	D29	DDI1_PAIR1+
C30	N/A	D30	DDI1_PAIR1-
C31	GND (FIXED)	D31	GND (FIXED)
C32	DDI2_CTRLCLK_AUX+ (Option)	D32	DDI1_PAIR2+
C33	DDI2DDI2_CTRLDATA_AUX - (Option)	D33	DDI1_PAIR2-
C34	DDI2_DDC_AUX_SEL (Option)	D34	DDI1_DDC_AUX_SEL
C35	RSVD	D35	RSVD
C36	N/A	D36	DDI1_PAIR3+
C37	N/A	D37	DDI1_PAIR3-
C38	N/A	D38	RSVD
C39	N/A	D39	DDI2_PAIR0+ (Option)
C40	N/A	D40	DDI2_PAIR0- (Option)
C41	GND (FIXED)	D41	GND (FIXED)
C42	N/A	D42	DDI2_PAIR1+ (Option)
C43	N/A	D43	DDI2_PAIR1- (Option)
C44	N/A	D44	DDI2_HPDP (Option)
C45	RSVD	D45	RSVD
C46	N/A	D46	DDI2_PAIR2+(Option)
C47	N/A	D47	DDI2_PAIR2- (Option)
C48	RSVD	D48	RSVD
C49	N/A	D49	DDI2_PAIR3+ (Option)
C50	N/A	D50	DDI2_PAIR3- (Option)
C51	GND (FIXED)	D51	GND (FIXED)
C52	N/A	D52	N/A
C53	N/A	D53	N/A
C54	N/A	D54	N/A
C55	N/A	D55	N/A
C56	N/A	D56	N/A
C57	N/A	D57	N/A
C58	N/A	D58	N/A
C59	N/A	D59	N/A
C60	GND (FIXED)	D60	GND (FIXED)
C61	N/A	D61	N/A
C62	N/A	D62	N/A
C63	RSVD	D63	RSVD
C64	RSVD	D64	RSVD
C65	N/A	D65	N/A
C66	N/A	D66	N/A
C67	RSVD	D67	GND
C68	N/A	D68	N/A
C69	N/A	D69	N/A
C70	GND (FIXED)	D70	GND (FIXED)

C71	N/A	D71	N/A
C72	N/A	D72	N/A
C73	GND	D73	GND
C74	N/A	D74	N/A
C75	N/A	D75	N/A
C76	GND	D76	GND
C77	RSVD	D77	RSVD
C78	N/A	D78	N/A
C79	N/A	D79	N/A
C80	GND (FIXED)	D80	GND (FIXED)
C81	N/A	D81	N/A
C82	N/A	D82	N/A
C83	RSVD	D83	RSVD
C84	GND	D84	GND
C85	N/A	D85	N/A
C86	N/A	D86	N/A
C87	GND	D87	GND
C88	N/A	D88	N/A
C89	N/A	D89	N/A
C90	GND (FIXED)	D90	GND (FIXED)
C91	N/A	D91	N/A
C92	N/A	D92	N/A
C93	GND	D93	GND
C94	N/A	D94	N/A
C95	N/A	D95	N/A
C96	GND	D96	GND
C97	RSVD	D97	N/A
C98	N/A	D98	N/A
C99	N/A	D99	N/A
C100	GND (FIXED)	D100	GND (FIXED)
C101	N/A	D101	N/A
C102	N/A	D102	N/A
C103	GND	D103	GND
C104	VCC_12V	D104	VCC_12V
C105	VCC_12V	D105	VCC_12V
C106	VCC_12V	D106	VCC_12V
C107	VCC_12V	D107	VCC_12V
C108	VCC_12V	D108	VCC_12V
C109	VCC_12V	D109	VCC_12V
C110	GND (FIXED)	D110	GND (FIXED)

Appendix **B**

Watchdog Timer

This appendix gives you the information about the watchdog timer programming on the SOM-6867 CPU System on Module

Sections include:

- Watchdog Timer Programming

B.1 Programming the Watchdog Timer

Trigger Event	Note
IRQ	IRQ5, 7, 14 (BIOS setting default disable)**
NMI	N/A
SCI	Power button event
Power Off	Support
H/W Restart	Support
External WDT	N/A

** WDT new driver support automatically select available IRQ number from BIOS, and then set to EC. Only Win7 and Win8 support it.

In other OS, it will still use IRQ number from BIOS setting as usual.

For details, please refer to iManager & Software API User Manual:

Appendix **C**

Programming GPIO

This Appendix gives the illustration of the General Purpose Input and Output pin setting.

Sections include:

- System I/O ports

C.1 GPIO Register

GPIO Byte Mapping	H/W Pin Name
BIT0	GPO0
BIT1	GPO1
BIT2	GPO2
BIT3	GPO3
BIT4	GPI0
BIT5	GPI1
BIT6	GPI2
BIT7	GPI3

For details, please refer to iManager & Software API User Manual

Appendix **D**

System Assignments

This appendix gives you the information about the system resource allocation on the SOM-6867 CPU System on Module

Sections include:

- System I/O ports
- DMA Channel Assignments
- Interrupt Assignments
- 1st MB Memory Map

D.1 System I/O Ports

Table D.1: System I/O ports

Addr.range(Hex)	Device
0000-006F	PCI bus
0020-0021	Programmable interrupt controller
0024-0025	Programmable interrupt controller
0028-0029	Programmable interrupt controller
002C-002D	Programmable interrupt controller
002E-002F	Motherboard resources
0030-0031	Programmable interrupt controller
0034-0035	Programmable interrupt controller
0038-0039	Programmable interrupt controller
003C-003D	Programmable interrupt controller
0040-0043	System timer
004E-004F	Motherboard resources
0050-0053	System timer
0061-0061	Motherboard resources
0062-0062	Microsoft ACPI-Compliant Embedded Controller
0063-0063	Motherboard resources
0065-0065	Motherboard resources
0066-0066	Microsoft ACPI-Compliant Embedded Controller
0067-0067	Motherboard resources
0070-0077	Motherboard resources
0070-0077	System CMOS/real time clock
0078-0CF7	PCI bus
0080-008F	Motherboard resources
0092-0092	Motherboard resources
00A0-00A1	Programmable interrupt controller
00A4-00A5	Programmable interrupt controller
00A8-00A9	Programmable interrupt controller
00AC-00AD	Programmable interrupt controller
00B0-00B1	Programmable interrupt controller
00B2-00B3	Motherboard resources
00B4-00B5	Programmable interrupt controller
00B8-00B9	Programmable interrupt controller
00BC-00BD	Programmable interrupt controller
029C-029D	Motherboard resources
02E8-02EF	Communications Port (COM4)
02F8-02FF	Communications Port (COM2)
0378-037F	Printer Port (LPT1)
03B0-03BB	Intel(R) Atom(TM) Processor E3800 Series/Intel(R) Celeron(R) Processor N2920/J1900
03C0-03DF	Intel(R) Atom(TM) Processor E3800 Series/Intel(R) Celeron(R) Processor N2920/J1900
03E8-03EF	Communications Port (COM3)
03F8-03FF	Communications Port (COM1)
0400-047F	Motherboard resources
04D0-04D1	Programmable interrupt controller
0500-05FE	Motherboard resources

Table D.1: System I/O ports

0600-061F	Motherboard resources
0680-069F	Motherboard resources
0778-077F	Printer Port (LPT1)
0A00-0A0F	Motherboard resources
0A10-0A1F	Motherboard resources
0D00-FFFF	PCI bus
D000-DFFF	Intel(R) Atom(TM)/Celeron(R)/Pentium(R) Processor PCI Express - Root Port 4 - 0F4E
E000-E01F	Intel(R) Atom(TM)/Celeron(R)/Pentium(R) Processor Platform Control Unit - SMBus Port - 0F12
E020-E03F	Intel(R) Atom(TM)/Celeron(R)/Pentium(R) Processor AHCI - 0F23
E040-E043	Intel(R) Atom(TM)/Celeron(R)/Pentium(R) Processor AHCI - 0F23
E050-E057	Intel(R) Atom(TM)/Celeron(R)/Pentium(R) Processor AHCI - 0F23
E060-E063	Intel(R) Atom(TM)/Celeron(R)/Pentium(R) Processor AHCI - 0F23
E070-E077	Intel(R) Atom(TM)/Celeron(R)/Pentium(R) Processor AHCI - 0F23
E080-E087	Intel(R) Atom(TM) Processor E3800 Series/Intel(R) Celeron(R) Processor N2920/J1900

D.2 DMA Channel Assignments

Table D.2: DMA channel assignments

Channel	Function
3	Printer Port (LPT1)

D.3 Interrupt Assignments

Table D.3: Interrupt assignments

Interrupt#	Interrupt source
IRQ 0	System Timer
IRQ 3	Communications Port (COM2)
IRQ 4	Communications Port (COM1)
IRQ 6	Communications Port (COM4)
IRQ 7	SUSI4 Driver
IRQ 8	High precision event timer
IRQ 10	Intel® Atom™/Celeron®/Pentium® Processor Platform Control Unit - SMBus Port - 0F12
IRQ 11	Communications Port (COM3)
IRQ 16	Intel® Atom™/Celeron®/Pentium® Processor PCI Express - Root Port 1 - 0F48
IRQ 17	Intel® Atom™/Celeron®/Pentium® Processor PCI Express - Root Port 2 - 0F4A
IRQ 18	Intel® Atom™/Celeron®/Pentium® Processor PCI Express - Root Port 3 - 0F4C
IRQ 19	Intel® Atom™/Celeron®/Pentium® Processor AHCI - 0F23
IRQ 19	Intel® Atom™/Celeron®/Pentium® Processor PCI Express - Root Port 4 - 0F4E
IRQ 22	High Definition Audio Controller

Table D.3: Interrupt assignments

IRQ 81~190	Microsoft ACPI-Compliant System
IRQ FFFFFFF6 (-10)	Intel® I210 Gigabit Network Connection #3
IRQ FFFFFFF7 (-9)	Intel® I210 Gigabit Network Connection #3
IRQ FFFFFFF8 (-8)	Intel® I210 Gigabit Network Connection #3
IRQ FFFFFFF9 (-7)	Intel® I210 Gigabit Network Connection #3
IRQ FFFFFFF10 (-6)	Intel® I210 Gigabit Network Connection #3
IRQ FFFFFFF11 (-5)	Intel® I210 Gigabit Network Connection #3
IRQ FFFFFFF12 (-4)	Intel® Trusted Execution Engine Interface
IRQ FFFFFFF13 (-3)	Intel® USB 3.0 eXtensible Host Controller
IRQ FFFFFFF14 (-2)	Intel® Atom™ Processor E3800 Series/Intel® Celeron® Processor N2920/J1900

D.4 1st MB Memory Map

Table D.4: 1st MB Memory Map

Addr. range (Hex)	Device
0xE0000-0xFFFFF	PCI bus
0xC0000-0xDFFFF	PCI bus
0xA0000-0xBFFFF	PCI bus
0xA0000-0xBFFFF	Intel® Atom™ Processor E3800 Series/Intel® Celeron® Processor N2920/J1900
0xFF000000-0xFFFFFFFF	Intel® 82802 Firmware Hub Device
0x90700000-0x907FFFFF	Intel® I210 Gigabit Network Connection #3
0x90800000-0x90803FFF	Intel® I210 Gigabit Network Connection #3
0x80000000-0x90915FFE	PCI bus
0x80000000-0x90915FFE	Intel® Atom™ Processor E3800 Series/Intel® Celeron® Processor N2920/J1900
0x90915000-0x909157FF	Intel® Atom™/Celeron®/Pentium® Processor AHCI - 0F23
0xE0000000-0xEFFFFFFF	Motherboard resources
0xFED01000-0xFED01FFF	Motherboard resources
0xFED03000-0xFED03FFF	Motherboard resources
0xFED04000-0xFED04FFF	Motherboard resources
0xFED08000-0xFED08FFF	Motherboard resources
0xFED1C000-0xFED1CFFF	Motherboard resources
0xFEE00000-0xFEEFFFFFFF	Motherboard resources
0xFE000000-0xFEFFFFFFF	Motherboard resources

Table D.4: 1st MB Memory Map

0x90910000- 0x90913FFF	High Definition Audio Controller
0x90900000- 0x9090FFFF	Intel® USB 3.0 eXtensible Host Controller
0x90500000- 0x905FFFFFF	Intel® Trusted Execution Engine Interface
0x90400000- 0x904FFFFFF	Intel® Trusted Execution Engine Interface
0x90000000- 0x903FFFFFF	Intel® Atom™ Processor E3800 Series/Intel® Celeron® Processor N2920/J1900
0x90914000- 0x9091401F	Intel® Atom(TM)/Celeron®/Pentium® Processor Platform Control Unit - SMBus Port - 0F12
0xFED00000- 0xFED003FF	High precision event timer
0x90600000- 0x908FFFFFF	Intel(R) Atom(TM)/Celeron(R)/Pentium(R) Processor PCI Express - Root Port 4 - 0F4E

ADVANTECH

Enabling an Intelligent Planet

www.advantech.com

Please verify specifications before quoting. This guide is intended for reference purpOS only.

All product specifications are subject to change without notice.

No part of this publication may be reproduced in any form or by any means, electronic, photocopying, recording or otherwise, without prior written permission of the publisher.

All brand and product names are trademarks or registered trademarks of their respective companies.

© Advantech Co., Ltd. 2015